

RL38S-R

6" Incandescent Shallow Remodel Recessed Housing

Catalog No. _____

Type _____

Project _____

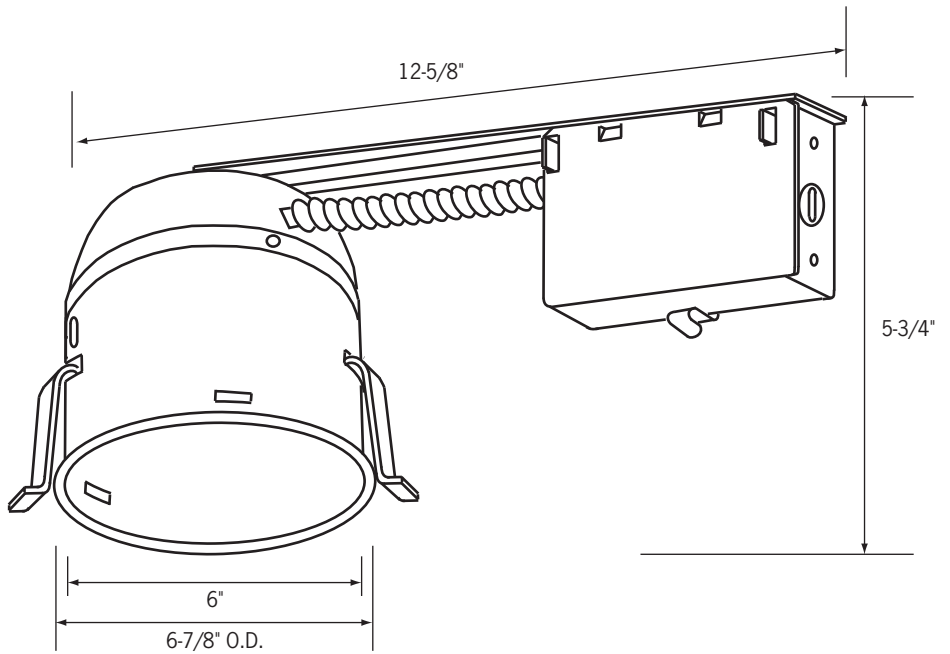

Ceiling Opening: 6-1/2"
Ceiling Thickness: 1/2" - 1-3/4"

Specifications/Features

Housing/Mounting

White steel housing.
Will work in ceiling thickness from 1/2" - 1-3/4".
Requires 3" minimum clearance in insulated ceilings.
Adjustable socket mounting plate (Vertical position).

Lamp/Electrical

(1) 60W A19, 65W BR30, 75W PAR30, 100W A19, 120W BR40 or 150W PAR38. (max.)
Prewired junction box with convenient screwdriver pry-outs: (4) 1/2", (1) 1/2"x3/4" concentric, and (4) Romex knockouts.
Spring-latch access plates.
Approved for through-branch (4 in/4 out) (8) #12 AWG wiring.

Trims

Baffle, multiplier, and adjustable accent trim options available to suit a broad range of applications. Innovative two stage lamp holder assembly. See attached "Trims for 6" Incandescent Recessed Housings" spec sheet for details.

Warranty

This fixture is covered by Con-Tech's full one year replacement guarantee after date of purchase.

Labels/Usage

cULus listed. Suitable for damp locations. New York City approved, calendar number 45707.

Ordering Information

Example Order:

Fixture

RL38S-R

Trims

Max. Lamp 60W A19:

CTR1903, CTR1912, CTR1913 and CTR1916 Series Trims; CTR1331-P

Max. Lamp 65W BR30 or 75W PAR30:

CTR3000, CTR3001, CTR3002, CTR3007, CTR3008 and CTR3009 Series Trims

Max. Lamp 100W A19:

CTR1901 and CTR1902 Series Trims

Max. Lamp 120W BR40 or 150W PAR38:

CTR3800, CTR3801 and CTR3802 Series Trims

See attached "Trims for 6" Incandescent Recessed Housings" Spec Sheet for Details



Trims for 6" Incandescent RL30 and RL38 Series Recessed Housings

Catalog No. _____

Type _____

Project _____

General Trim Information

All trims are compatible with **6 Inch Incandescent RL30 and RL38 Series Recessed Housings**. See specific housing spec sheet for trim compatibility.

All trims have white trim finish unless specified.

All trims are cULus listed.

All trims are suitable for damp locations; only shower trims are listed for wet locations.

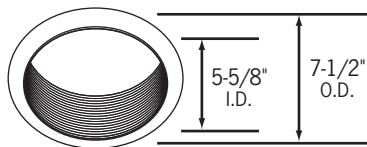

CTR1901-B-CLR

Black Baffle, Clear Reflector, Black Trim Ring

CTR1901-CLR

Black Baffle, Clear Reflector

CTR1901-WHT

White Baffle, White Reflector

ETL listed for use with four other housing manufacturers. White high heat rated ABS beveled trim ring. Specular aluminum reflector. (3) Heat-treated steel spring reflector clips.

Maximum Wattage:

IC Housings: 50W PAR30, 60W A19

Non-IC Housings: 75W PAR30, 90W PAR38, 100W A19

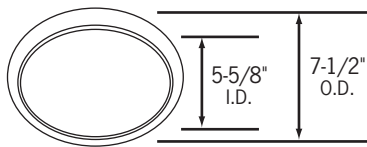

CTR1902-(CLR, WHT)

A-Lamp Multiplier, Clear or White Reflector

ETL listed for use with four other housing manufacturers. White high heat rated ABS beveled trim ring. Specular aluminum reflector. (3) Heat-treated steel spring pressure clips.

Maximum Wattage:

IC Housings: 50W PAR30, 60W A19

Non-IC Housings: 75W PAR30, 90W PAR38, 100W A19

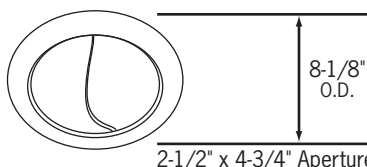

CTR1903-P

Scoop Wall Wash

White beveled steel trim ring. Polyethylene sponge gaskets. (2) Butterfly spring clips, heat-treated steel. All steel construction.

Maximum Wattage:

IC Housings: 40W A19 (60W A19 with RL38-ICER/ICESA housings)

Non-IC Housings: 60W A19

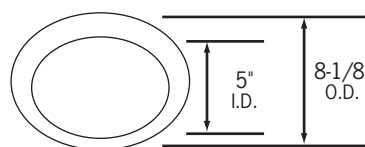

CTR1912-P

Albalite Shower Light Trim

Wet location listed. Beveled white steel trim ring. Polyethylene sponge gaskets. Flat opal Albalite glass. (2) Butterfly spring clips, heat treated steel. ETL listed for use with four other housing manufacturers.

Maximum Wattage:

IC Housings: 40W A19 (60W A19 with RL38-ICER/ICESA housings)

Non-IC Housings: 60W A19

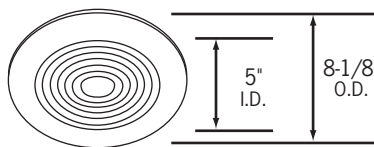

CTR1913-P

Fresnel Shower Light Trim

Wet location listed. Beveled white steel trim ring. Polyethylene sponge gaskets. Flat, clear Fresnel glass lens. (2) Butterfly spring clips, heat treated steel. ETL listed for use with four other housing manufacturers.

Maximum Wattage:

IC Housings: 40W A19 (60W A19 with RL38-ICER/ICESA housings)

Non-IC Housings: 60W A19

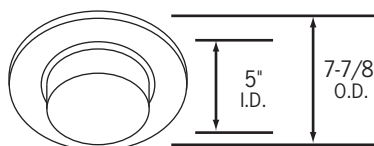

CTR1916-P

Drop Opal Shower Light Trim

Glass Lens, 1" Drop

Wet location listed. Beveled white steel trim ring. Polyethylene sponge gaskets. (2) Butterfly spring clips, heat treated steel. ETL listed for use with four other housing manufacturers.

Maximum Wattage:

IC Housings: 40W A19

Non-IC Housings: 60W A19

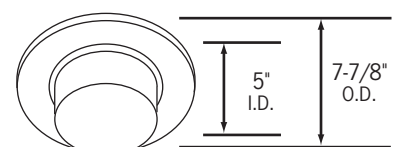

CTR1916-PP

Drop Opal Shower Light Trim
Plastic Lens, 1-1/2" Drop

Wet location listed. Beveled white high-heat ABS trim ring. Polyethylene sponge gaskets. (2) Butterfly spring clips, heat treated steel. ETL listed for use with four other housing manufacturers.

Maximum Wattage:

IC Housings: 40W A19

Non-IC Housings: 60W A19

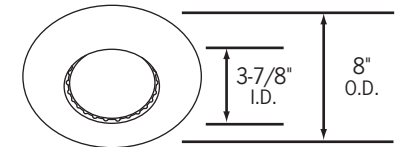

CTR3000-P

Open Trim

Maximum Wattage: 75W PAR30

CTR3800-P

Open Trim

Maximum Wattage:

IC Housings: 75W PAR38, 90W PAR38, 100W PAR38

Non-IC Housings: 120W BR40, 150W PAR38

ETL listed for use with four other housing manufacturers. White steel beveled trim ring. (2) Double coiled heat-treated steel spring clips. Polyethylene sponge gaskets.

Continued on Page 2



1-800-728-0312

www.con-techlighting.com

All specifications subject to change without notice.

Trims for 6" Incandescent RL30 and RL38 Series Recessed Housings

Catalog No. _____

Type _____

Project _____

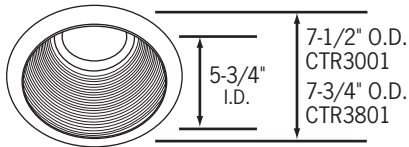

CTR3001-(B, P, U, WHT)

Tapered Black Baffle (Black Trim Ring), Black Baffle (White Trim Ring), UnLook Baffle (UnLook Trim Ring) or White Baffle (White Trim Ring)

Maximum Wattage: 65W BR30, 75W PAR30

CTR3801-(B, P, U, WHT)

Tapered Black Baffle (Black Trim Ring), Black Baffle (White Trim Ring), UnLook Baffle (UnLook Trim Ring) or White Baffle (White Trim Ring)

Maximum Wattage:

IC Housings: 75W PAR38, 90W PAR38, 100W PAR38

Non-IC Housings: 120W BR40, 150W PAR38

ETL listed for use with four other housing manufacturers. White high heat rated ABS beveled trim ring. (2) Double coiled heat-treated steel spring clips. Tapered steel baffle.

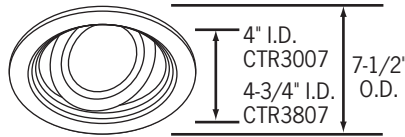

CTR3007-(P, WHT)

Recessed Gimbal
Black, UnLook (and Trim) or White Baffle

Maximum Wattage: 65W BR30, 75W PAR30

CTR3807-(P, WHT)

Recessed Gimbal
Black, UnLook (and Trim) or White Baffle

Maximum Wattage:

IC Housings: 75W PAR38, 90W PAR38, 100W PAR38

Non-IC Housings: 150W PAR38

23° Vertical adjustment. Flat, high heat ABS white trim ring. (3) Leaf reflector clips, spring steel, heat-treated. Steel baffle construction. (1) Steel, heat-treated lamp retaining spring.

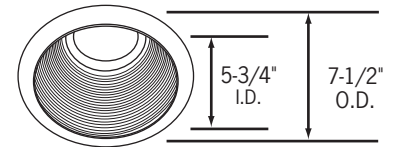

CTR6001AT(B, WHT)

Self flanged, air-tight, tapered baffle.
Black Baffle (Black Trim Ring) or White Baffle (White Trim Ring)

Maximum Wattage:

IC Housings: 75W PAR30

Non-IC Housings: 150W PAR38

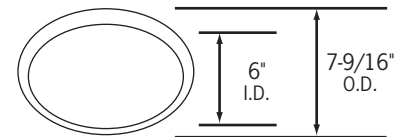

CTR62250-WHT

Self Flanged Heat Lamp

White steel trim.

Maximum Wattage: 250W R40 Heat Lamp

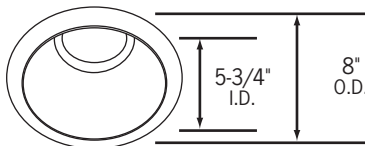

CTR3002-B-BLK

Black Specular Reflector, Black Trim

Maximum Wattage: 65W BR30, 75W PAR30

CTR3002-(BLK, CLR, WHT)

Black, Clear, Gold or White Specular Reflector, UnLook Multiplier and Trim

Maximum Wattage: 65W BR30, 75W PAR30

CTR3802-B-BLK

Black Specular Reflector, Black Trim Ring

Maximum Wattage:

IC Housings: 75W PAR38, 90W PAR38, 100W PAR38

Non-IC Housings: 120W BR40, 150W PAR38

CTR3802-(BLK, CLR, WHT)

Black, Clear, Gold or White Specular Reflector, UnLook Multiplier and Trim

Maximum Wattage:

IC Housings: 75W PAR38, 90W PAR38, 100W PAR38

Non-IC Housings: 120W BR40, 150W PAR38

ETL listed for use with four other housing manufacturers. White high heat rated ABS beveled trim ring. (2) Double coiled heat-treated steel spring clips. Tapered steel baffle.

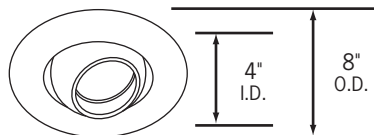

CTR3008-(B, P)

Eyeball

35° Vertical adjustment. Beveled steel trim ring. Polyethylene sponge gaskets. (2) Butterfly spring clips, heat-treated steel. Steel eyeball construction. ETL listed for use with four other housing manufacturers.

Maximum Wattage: 75W PAR30

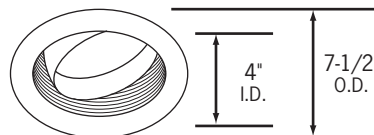

CTR3009-(P, WHT)

Regressed Eyeball, Black or White Baffle

30° Vertical adjustment. Flat, high-heat ABS white trim ring. (3) Leaf reflector clips: spring steel, heat-treated, black oxidation plated. White aluminum tapered baffle. White steel eyeball construction.

Maximum Wattage: 75W PAR30



1-800-728-0312

www.con-techlighting.com

All specifications subject to change without notice.