

RL38A-IC

6" Vertical Lamp Sloped Ceiling Housing

Catalog No. _____

Type _____

Project _____

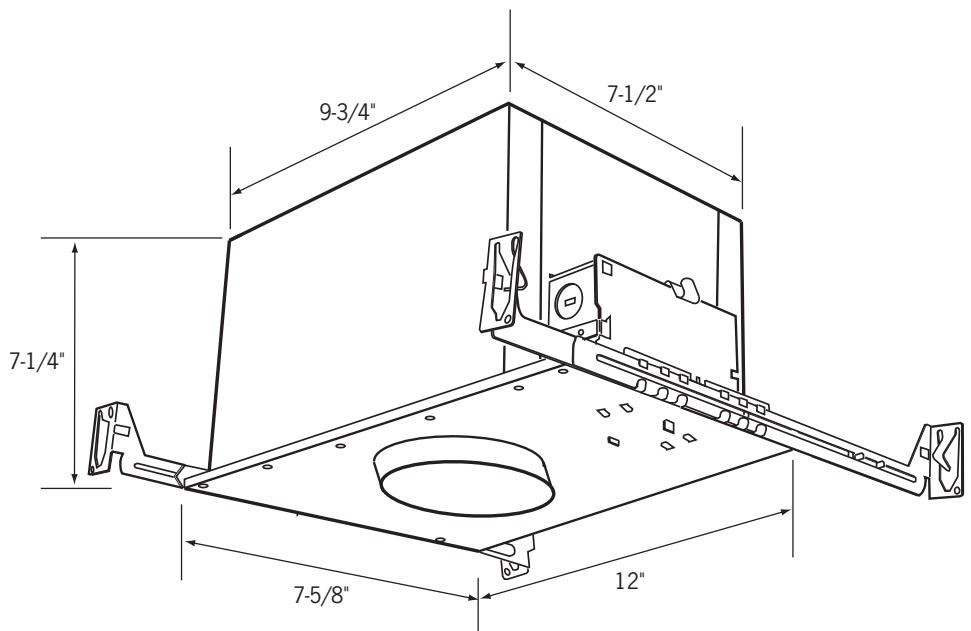

Elliptical Ceiling Opening: 7-1/16" x 6-7/8"

Specifications/Features

Housing

This housing is designed for residential and commercial sloped ceilings for direct contact with ceiling insulation in all ceiling construction. The elliptical aperture matches the ceiling slope.

Suitable for installation in 9 - 27 degree angle (2/12 to 6/12 pitch) existing sloped ceilings. Template supplied for elliptical hole.

Will work in ceiling thickness from 1/2" - 1-1/2". Adjustable bar hanger: 14-1/4" > 24-1/2".

Adjustable socket allows proper lamp position.

Lamp/Electrical

(1) 90W PAR38 or 120W BR40 lamp (max).

Pre-wired junction box with convenient screwdriver pry-outs:

(4) 1/2", (1) 1/2" and 3/4" concentric, (4) Romex pry-outs with UL listed cable grips.

Spring-latch access plate.

Approved for through-branch wiring. Maximum (8) #12 AWG wires (4-in/4-out).

Trims

Many different trims are available to complement any design style. See attached "Trims for 6" Sloped Ceiling Recessed Housings" spec sheet for details.

Warranty

This fixture is covered by Con-Tech's full one year replacement guarantee after date of purchase.

Listing

cULus listed. Suitable for damp locations.

Ordering Information

Example Order:

RL38A-IC

CTR131-P

HB-24

Housing

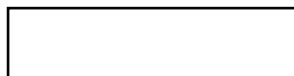

RL38A-IC

Trims

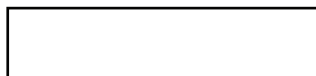

For Trims, see attached "Trims for 6" Sloped Ceiling Recessed Housings" spec sheet.

Options



CTR64C-CLR - 6" Crosshair Louver Insert
HB-24 - 27" Flat Hanger Set for RL-KIT/Grid Ceiling
HBC-24 - 25" C-Channel Hanger Set for RL-KIT/Grid Ceiling
HB-30 - T-Bar Hanger Set
RL-KIT - Commercial Mounting Brackets
RL-725-(B, P) - Minimum Trim Ring for 6" Trim, 7-1/4" O.D.
RL-75-(B, P) - Replacement Trim Ring for 6" Trim, 7-1/2" O.D.
RL-08-(B, P) - Oversized Trim Ring for 6" Trim, 7-13/16" O.D.



1-800-728-0312

www.con-techlighting.com

All specifications subject to change without notice.

Trims for 6" Vertical Lamp Sloped Ceiling Recessed Housings

Catalog No. _____

Type _____

Project _____

General Trim Information

All trims are compatible with **6 Inch Vertical Lamp Sloped Ceiling Incandescent Recessed Housings**.

All trims have white trim finish unless specified.

All trims are cULus listed.

All trims are suitable for damp locations; only shower trims are listed for wet locations.

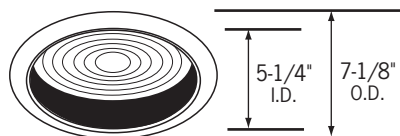

CTR1331-P

Black Baffle, Regressed Glass Fresnel Lens

CTR1331-P-WHT

White Baffle, Regressed Glass Fresnel Lens

Regressed fresnel lensed trims feature focused illumination. Trims are adjustable to accommodate different ceiling thicknesses.

Max. Lamp:

RL38A, RL38A-IC, RL38A-ICS: **75W PAR30, 60W A19;**

RL38A-ICE, RL38A-ICR: **50W PAR30, 40W A19**

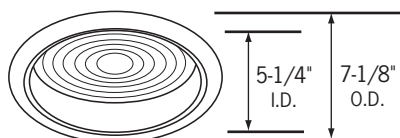

CTR1332-P-CLR

Clear Multiplier, Regressed Convex Prismatic Lens

CTR1332-P-WHT

White Multiplier, Regressed Convex Prismatic Lens

Regressed fresnel lensed trims feature focused illumination. Trims are adjustable to accommodate different ceiling thicknesses.

Max. Lamp:

RL38A, RL38A-IC, RL38A-ICS: **75W PAR30, 60W A19;**

RL38A-ICE, RL38A-ICR: **50W PAR30, 40W A19**



CTR1903-P

Scoop Wall Wash

White beveled steel trim ring. Polyethylene sponge gaskets. (2) Butterfly spring clips. All heat-treated steel construction.

Max. Lamp:

RL38A, RL38A-IC, RL38A-ICS: **60W A19;**
RL38A-ICE, RL38A-ICR: **40W A19**

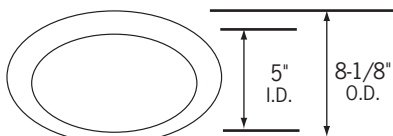

CTR1912-P

Albalite Shower Trim

Wet location listed. White beveled steel trim ring. Polyethylene sponge gaskets. Flat opal Albalite glass. (2) Butterfly spring clips. Heat-treated steel. ETL listed for use with four other housing manufacturers.

Max. Lamp:

RL38A, RL38A-IC, RL38A-ICS: **60W A19;**
RL38A-ICE, RL38A-ICR: **40W A19**

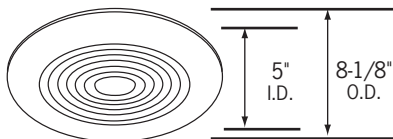

CTR1913-P

Fresnel Shower Trim

Wet location listed. White beveled steel trim ring. Polyethylene sponge gaskets. Flat, clear Fresnel glass lens. (2) Butterfly spring clips. Heat-treated steel. ETL listed for use with four other housing manufacturers.

Max. Lamp:

RL38A, RL38A-IC, RL38A-ICS: **60W A19;**
RL38A-ICE, RL38A-ICR: **40W A19**

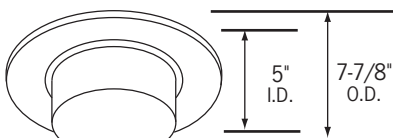

CTR1916-P

Drop Opal Shower Light, Glass Lens, White Beveled Steel Trim, 1" Drop from Ceiling

CTR1916-PP

Drop Opal Shower Light, Plastic Lens, White High Heat ABS Trim, 1-1/2" Drop from Ceiling

Wet location listed. Polyethylene sponge gaskets. Flat, clear Fresnel glass lens. (2) Butterfly spring clips. Heat-treated steel. ETL listed for use with four other housing manufacturers.

Max. Lamp:

RL38A, RL38A-IC, RL38A-ICS: **60W A19;**
RL38A-ICE, RL38A-ICR: **40W A19**

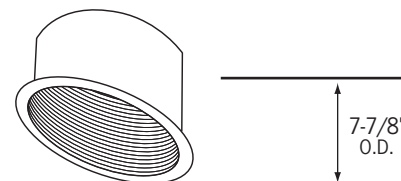

CTR3801SC-(P, WHT)

Baffle Trim

Fabricated of one piece of aluminum. (3) Leaf reflector clips, spring steel, heat-treated, black oxidation plated. White flat plastic trim ring supplied. Black (P) or White (WHT) baffle.

Max. Lamp:

RL38A, RL38A-IC, RL38A-ICS: **120W BR40, 90W PAR38;**

RL38A-ICE, RL38A-ICR: **75W BR40, 75W PAR38**

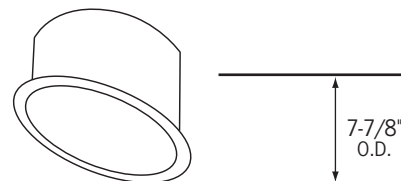

CTR3802SC-(BLK, CLR, GLD, WHT)

Multiplier Trim

Fabricated of one piece of aluminum. (3) Leaf reflector clips, spring steel, heat-treated, black oxidation plated. White flat plastic trim ring supplied. Black (BLK), Clear (CLR), Gold (GLD) or White (WHT) multiplier.

Max. Lamp:

RL38A, RL38A-IC, RL38A-ICS: **120W BR40, 90W PAR38;**

RL38A-ICE, RL38A-ICR: **75W BR40, 75W PAR38**



Trims for 6" Vertical Lamp Sloped Ceiling Recessed Housings

Catalog No. _____

Type _____

Project _____

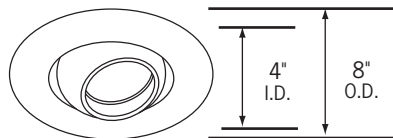

CTR3008-(B, P)

Eyeball Trim

35° Vertical adjustment. Beveled steel trim ring. Polyethylene sponge gaskets. (2) Butterfly spring clips. Heat-treated steel. ETL Listed for use with four other housing manufacturers. Steel eyeball construction.

Max. Lamp: 75W PAR30



RLA19-(BLK, CLR, WHT)

A-Lamp Reflector Cone

Fabricated of one piece of aluminum. **Must be used with CTR3801SC or CTR3802SC trim when using an A19 lamp.** Black (BLK), Clear (CLR), or White (WHT).

Max. Lamp:

RL38A, RL38A-IC, RL38A-ICS: 100W A19

RL38A-ICE, RL38A-ICR: 75W A19

