

RL20-R

4" Line Voltage Mini-Recessed Housing, Remodel Version

Catalog No. _____

Type _____

Project _____

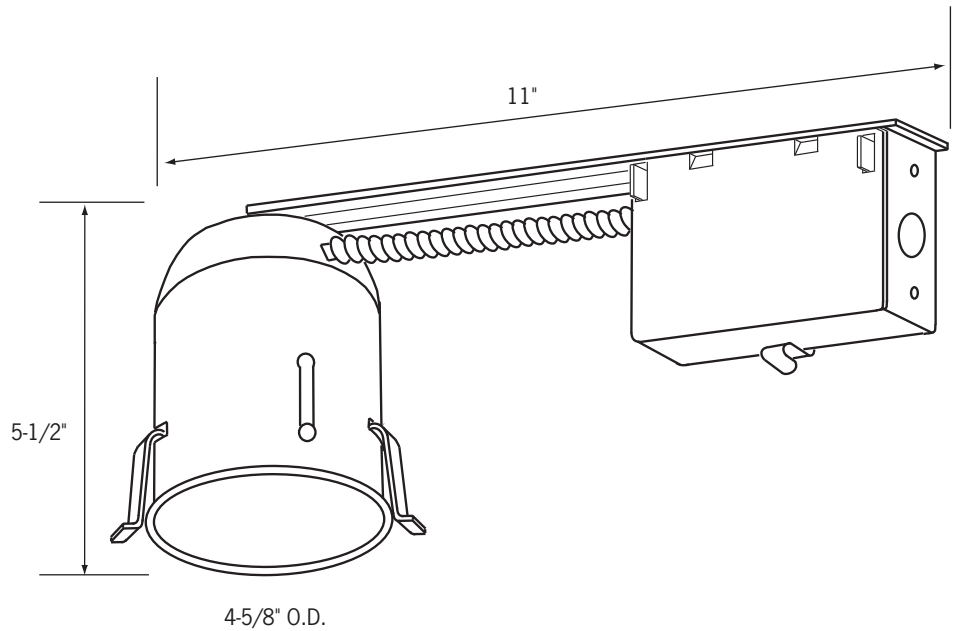

Ceiling Opening: 4-3/8"

Specifications/Features

Housing

May be used in all types of ceiling construction. Retractable mounting clips allow for easy installation into existing ceiling. Clips go inside and hold firmly to dry wall. Requires 3" minimum clearance in insulated ceilings. Will work in ceiling thickness from 1/2" to 1-1/2". Ceiling template provided.

Lamp/Electrical

(1) 50W R20, 50W PAR20 or 45W PAR16 max.
Thermally protected.
Maximum of (8) No. 12 AWG conductors.
Junction Box has (8) 1/2" pry-outs and (4) Romex pry-outs.
Adjustable lamp socket, vertical position.

Trims

Many different trims are available to complement any design style. See attached "Trims for 4" Line voltage Mini-Recessed Housings" spec sheet for details.

Warranty

This fixture is covered by Con-Tech's full one year replacement guarantee after date of purchase.

Listing

cULus listed. Suitable for damp locations.
New York City approved. Calendar number 38645.

Ordering Information

Example Order:

RL20-R

CTR200-P

Housing

RL20-R

Trims

For Trims, see attached "Trims for 4" Line Voltage Mini-Recessed Housings" spec sheet.



1-800-728-0312

www.con-techlighting.com

All specifications subject to change without notice.

Trims for 4" Line Voltage Incandescent Mini-Recessed Housings

Catalog No. _____

Type _____

Project _____

General Trim Information

All trims are compatible with 4 Inch Line Voltage Incandescent Mini-Recessed Housings.

All trims have white trim finish unless specified.

All trims are cULus listed.

All trims are suitable for damp locations; only shower trims are listed for wet locations.

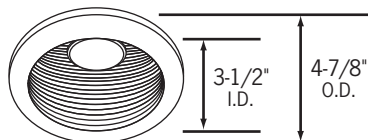

CTR2001-P

Black Baffled Downlight

CTR2001W-P

White Baffled Downlight

All steel construction. (3) heat treated spring steel mounting clips. Black socket aiming bracket with screws (provided in carton).

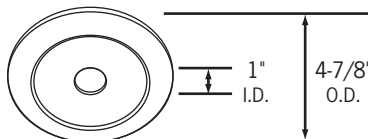

CTR2005-P

Mini-recessed Pin Spot

All steel construction. (3) heat treated spring steel mounting clips. Black socket aiming bracket with screws (provided in carton). Aluminum reflector.

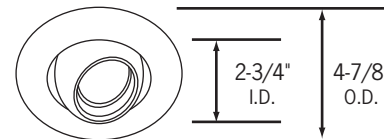

CTR2008-(P, U)

Mini-recessed Eyeball

30° vertical adjustment. All steel construction. (3) heat treated spring steel mounting clips.

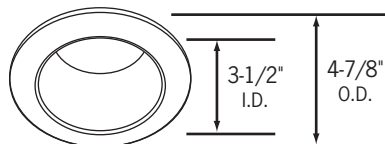

CTR2002-BLK-B

Black Specular Aluminum Reflector

CTR2002-BLK-P

Black Specular Aluminum Reflector

CTR2002-CLR-P

Clear Specular Aluminum Reflector

CTR2002-GLD-P

Gold Specular Aluminum Reflector

CTR2002-WHT-P

White Specular Aluminum Reflector

All steel construction. (3) heat treated spring steel mounting clips. Black socket aiming bracket with screws (provided in carton).

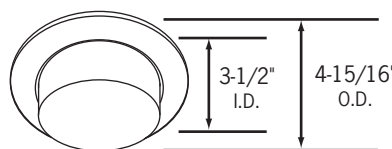

CTR2006-P

Drop Opal Glass Shower Light

All steel construction. (3) heat treated spring steel mounting clips. 1/8" thick heavy duty polyethylene sponge gasket. Wet location listed. 35W PAR20 maximum lamp.

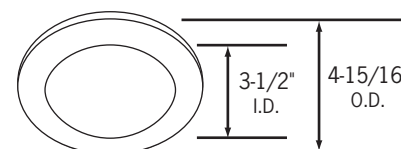

CTR2012-P

Flat Alabite Glass Lens Shower Light

All steel construction. (3) heat treated spring steel mounting clips. 1/8" thick heavy duty polyethylene sponge gasket. Wet location listed. 35W PAR20 maximum lamp.

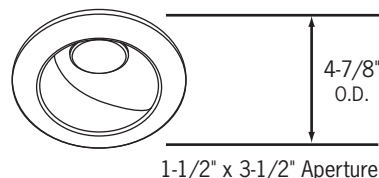

CTR2003-P

Mini-recessed Scoop Wall Wash

All steel construction. (3) heat treated spring steel mounting clips. Black socket aiming bracket with screws (provided in carton).

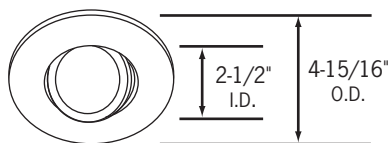

CTR2007-(P, B, NK, PB, S)

Surface Adjustable

28° vertical adjustment. All steel construction. (3) heat treated spring steel mounting clips. Lamp retaining sweep spring clip. 50W PAR20 maximum lamp.

Reflector/Trim Finishes

Reflector Finish Options:

- CLR - Clear, Specular
- GLD - Gold, Specular
- BLK - Black, Specular
- WHT - White Light, Specular

Trim Finish Options:

- B - Black
- NK - Nickel
- P - White
- PB - Polished Brass
- S - Silver
- U - UNLook



1-800-728-0312

www.con-techlighting.com

All specifications subject to change without notice.