



WP1GSN50/PC



JOB NAME: _____
 DATE: _____
 TYPE: _____

DESCRIPTION

The same Wallpack as the WP1, but with prismatic glass lens to eliminate yellowing. Lamp supplied.

SPECIFICATIONS

Finish:

Chip and fade resistant polyester powder coating.

Housing:

Die cast aluminum, 1/2" NPS tapped top, both sides and back for conduit or photocontrol. Hinged refractor. Continuous one piece silicone rubber gasket.

Reflector:

Semi-Specular anodized aluminum, removable for installation. Symmetrical light pattern maximizes distance between fixtures.

Conduit Openings:

Top, side, and back

UL Listing:

Suitable for wet locations. HID fixtures can be wired with 90° C supply wiring if supply wires are routed 3" away from the ballast.

Patents:

Pat. D440,683

Photocontrol:

Button Photocontrol installed and wired for 120V

Template:

Drilling template for easy wall box mounting

Color:

Bronze

Weight:

8.32

DIMENSIONS

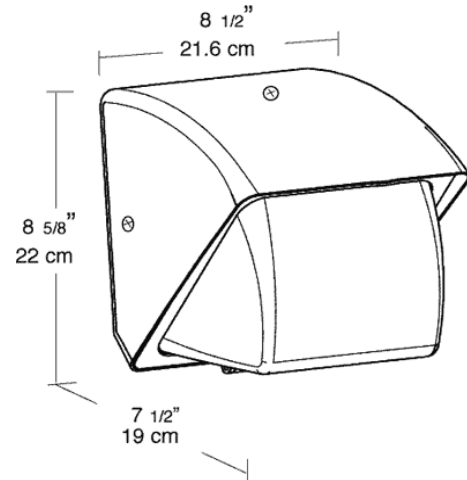

PHOTOMETRIC

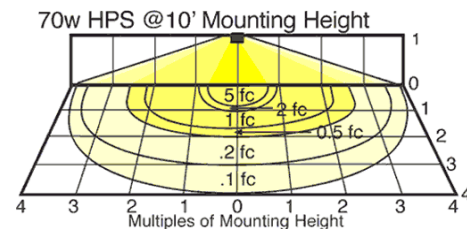

Mounting Height	Multiplier
8'	1.6
10'	1.0
12'	.7
16'	.4
20'	.25

Multiplier	Watts	HPS	MH	CFL
1.6	100	1.5	1.4	
1.0	70	1.0	.9	
.7	50	.6	.5	
.4	35	.4	.5	
.25	42		.5	

ORDERING INFORMATION

High Pressure Sodium
 Lamp supplied with fixture

Total Watts	Lamp Type	Lamp Base	Ballast
50	ED17	Medium	R-NPF 120V

Starting Amps/ Operating Amps			
120V	208V	240V	277V
1.8/1.2			

Input Watts	LAMP ANSI	Initial Lumens	Lamp Hours
62	S68	4000	24000

Factory Installed Options
 Add suffix to Catalog Number

Tamperproof screws (/TP)
 Swivel Photocontrol (/PCS)
 Single fusing for 120 and 277 volt (/F)

Button Photocontrol wired for 208 - 277 volt (/PC2)
 Button Photocontrol (/PC)

Note: Specifications may change without notice