



# WP1GSN35



JOB NAME: \_\_\_\_\_  
 DATE: \_\_\_\_\_  
 TYPE: \_\_\_\_\_

## DESCRIPTION

The same Wallpack as the WP1, but with prismatic glass lens to eliminate yellowing. Lamp supplied.

## SPECIFICATIONS

### Finish:

Chip and fade resistant polyester powder coating.

### Housing:

Die cast aluminum, 1/2" NPS tapped top, both sides and back for conduit or photocontrol. Hinged refractor. Continuous one piece silicone rubber gasket.

### Reflector:

Semi-Specular anodized aluminum, removable for installation. Symmetrical light pattern maximizes distance between fixtures.

### UL Listing:

Suitable for wet locations. HID fixtures can be wired with 90° C supply wiring if supply wires are routed 3" away from the ballast.

### Conduit Openings:

Top, side and back

### Patents:

Pat. D440,683

### Template:

Drilling template for easy wall box mounting

### Color:

Bronze

### Weight:

7.17

## DIMENSIONS

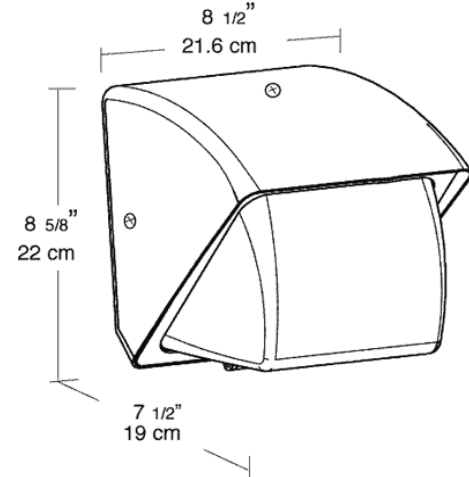

## PHOTOMETRIC

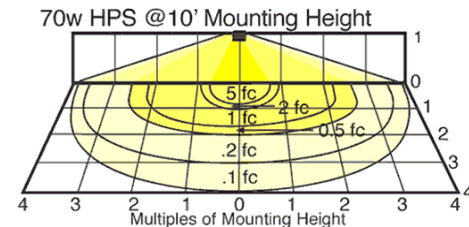

Mounting Height	Multiplier	Multiplier		
		Watts	HPS	MH CFL
8'	1.6	100	1.5	1.4
10'	1.0	70	1.0	.9
12'	.7	50	.6	.5
16'	.4	35	.4	.5
20'	.25	42		.5

## ORDERING INFORMATION

**High Pressure Sodium**  
 Lamp supplied with fixture

Total Watts	Lamp Type	Lamp Base	Ballast
35	ED17	Medium	R-NPF 120V

Starting Amps/ Operating Amps			
120V	208V	240V	277V
1.4/0.9			

Input Watts	LAMP ANSI	Initial Lumens	Lamp Hours
46	S76	2250	24000

**Factory Installed Options**  
 Add suffix to Catalog Number

Tamperproof screws (/TP)  
 Swivel Photocontrol (/PCS)  
 Single fusing for 120 and 277 volt (/F)

Button Photocontrol wired for 208 - 277 volt (/PC2)  
 Button Photocontrol (/PC)

Note: Specifications may change without notice