



FZH400SFQT



JOB NAME: _____
 DATE: _____
 TYPE: _____

DESCRIPTION

Floodzilla with integral slipfitter for O.D. 2 3/8" tenon size. slipfitter joint adjusts over 180° arc. Lamp supplied.

SPECIFICATIONS

Finish:

Chip and fade resistant polyester powder coating

Housing:

Precision die cast aluminum

Lens Gasket:

Molded one-piece silicone in die cast retaining groove to remain in place during relamping

Lens:

Tempered shock resistant glass

Reflector:

High quality anodized aluminum

Socket:

Glazed porcelain 4kv pulse rated with nickel plated screw shell and spring contacts

UL Listing:

Suitable for wet locations. Suitable for mounting within 4' of the ground.

EPA:

1.3

Patents:

Pat. D547,478

Quad Tap:

Fixture works with 120, 208, 240 and 277 Volts

Color:

Bronze

Weight:

29.9

DIMENSIONS

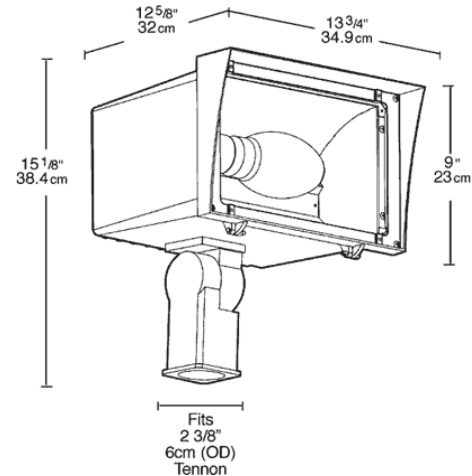

PHOTOMETRIC

400w HPS fixture @30' mounting height aimed @45° below horizontal

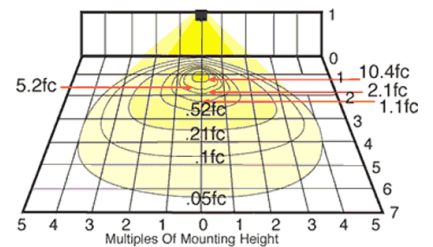

Mounting Height	Multiplier	Watts	Multiplier
40'	.6	175	.3
30'	1.0	200PS	.4
25'	1.4	250	.6 .4
20'	2.3	250PS	.5
15'	4.0	320PS	.6
		350PS	.7
		400	1.0 .7
		400PS	.8

ORDERING INFORMATION

Metal Halide Lamp supplied with fixture	Total Watts	Lamp Type	Lamp Base	Ballast	Starting Amps/ Operating Amps				Input Watts	LAMP ANSI	Initial Lumens	Lamp Hours
					120V	208V	240V	277V				
	400	ED28	Mogul	CWA-HPF QT	3.5/4.0	2.0/2.3	1.8/2.0	1.5/1.8	458	M59	36000	20000

Factory Installed Options
 Add suffix to Catalog Number

Swivel Photocontrol wired for 120V (/PCS) Button Photocontrol wired for 120V (/PC)
 Button Photocontrol wired for 480 (/PC4) 480 volt only ballast (/480)
 Button Photocontrol wired for 208 - 277V (/PC2)

Note: Specifications may change without notice