

EZHH100/480



JOB NAME: _____
DATE: _____
TYPE: _____

DESCRIPTION

Versatile MH Floodlight with hinged lens frame and hydroformed reflector. Field adjustable vertical and horizontal lamp positions. Lamp supplied.

SPECIFICATIONS

Finish:

Chip and fade resistant polyester powder coat finish

Ground Mounting:

Use the new MPM19 PVC Mighty Post with aluminum cap for sturdy installation

Housing:

Precision die cast aluminum. 1/2" NPS threaded arm with locking swivel

Lens Frame:

Precision die cast aluminum. Hinged for easy access

Lens Gasket:

High temperature tubular silicone set in die cast retaining groove remains in place during relamping.

Reflector:

Hydroformed aluminum. Field adjustable vertical or horizontal

Socket:

Porcelain 4kv Pulse Rated socket with nickel plated screw shell

UL Listing:

Suitable for wet locations. Suitable for mounting within 4' of the ground

Ballast Volts:

480 V

EPA:

0.6

Patents:

RAB sensor and fixture designs are protected under U.S. and International Intellectual Property laws

Color:

Bronze

Weight:

16

DIMENSIONS

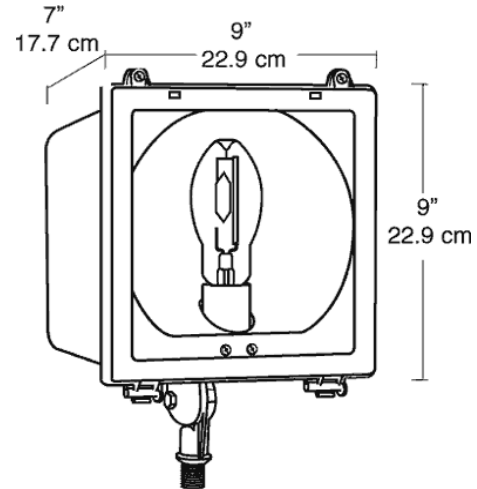

PHOTOMETRIC

150w HPS @ 10' Mounting Height
Aimed 30° below horizontal

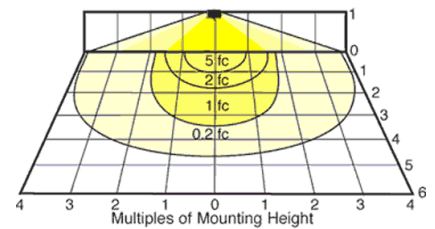

Mounting Height	Multiplier	Watts	Multiplier HPS	Multiplier MH
8'	1.6	175	.9	
10'	1.0	150PS	1.0	
12'	.7	150	1.0	.8
16'	.4	100	.6	.6
20'	.3	70	.4	.4
		50	.3	.2
		35	.2	

ORDERING INFORMATION

Metal Halide Lamp supplied with fixture	Total Watts	Lamp Type	Lamp Base	Ballast	Starting Amps/ Operating Amps				Input Watts	LAMP ANSI	Initial Lumens	Lamp Hours
					120V	208V	240V	277V				
	100	ED17	Medium	CWA-HPF 480V					0	M90	9000	15000

Factory Installed Options
Add suffix to Catalog Number

Swivel Photocontrol wired for 120V (/PCS) Dual Tap works with 120 / 277 volts (/DT)
Quad Tap works with 120, 208, 240 and 277 volts (/QT) Photocontrol wired for 120V (/PC)

Note: Specifications may change without notice