



MODEL-MIL-1200 (15)

Product Description and Measurements

Millennium Series

Installation Instruction

Single Lever Washbasin Mixer

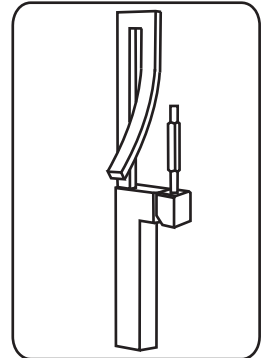

Thank You

Dear Valued Customer,
Kraus would like to take this opportunity to thank you for purchasing Kraus products. It is our sincere hope that you are completely satisfied with your new purchase. We welcome any questions or comments you may have and look forward to assisting you in the future.

Sincerely,
Kraus customer service department.

Prior To Installation Steps

1. Unpack your new product and ensure that all the parts are contained in the packaging. Keep the product in its original box until you ready to install it.
2. Shut off the water supply if replacing a previously-installed faucet.
3. Observe all plumbing and building codes in your area.
4. It is recommended that installation of the product be done by a professional plumber.

Contact us toll-free at 1-800-775-0703; or visit our website at www.kraususa.com.

Installation

Code	Parts List	Quantity
1	Spout	1
2	Main mixer	1
3	Joystick	1
4	Handle	1
5	Hose	1
6	O-ring	1
7	Lock washer (rubber)	2
8	Lock washer (brass)	1
9	Screw pole	1
10	Nut	1

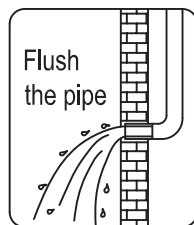
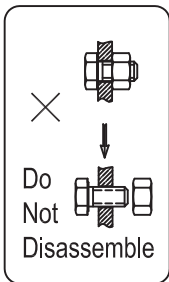
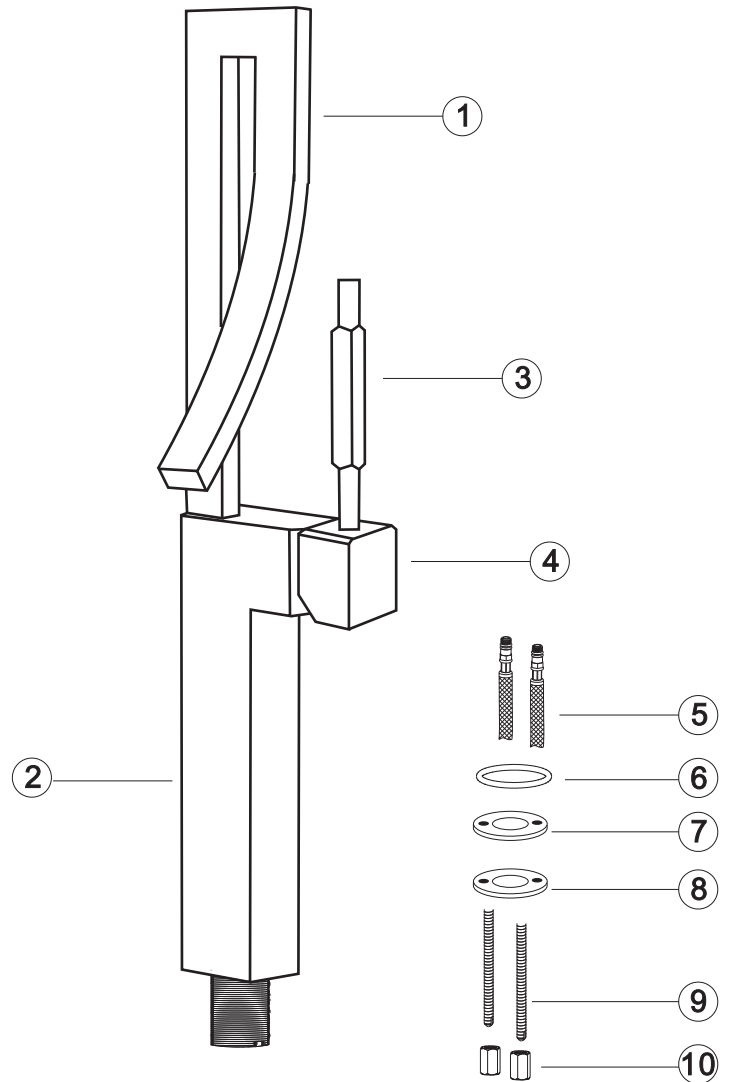

Do not disassemble the main body, as it has been installed & commissioned correctly & precisely before leaving the factory.
 To avoid the faucet from jamming, DO flush the water pipe before installation.
 After installation make sure every joint is safely sealed (NO LEAKAGE).
 Make sure to connect the hot/cold inlet pipe correctly from front view hot water pipe connecting to the left and cold water pipe connecting to the right .

Installation

Step 1

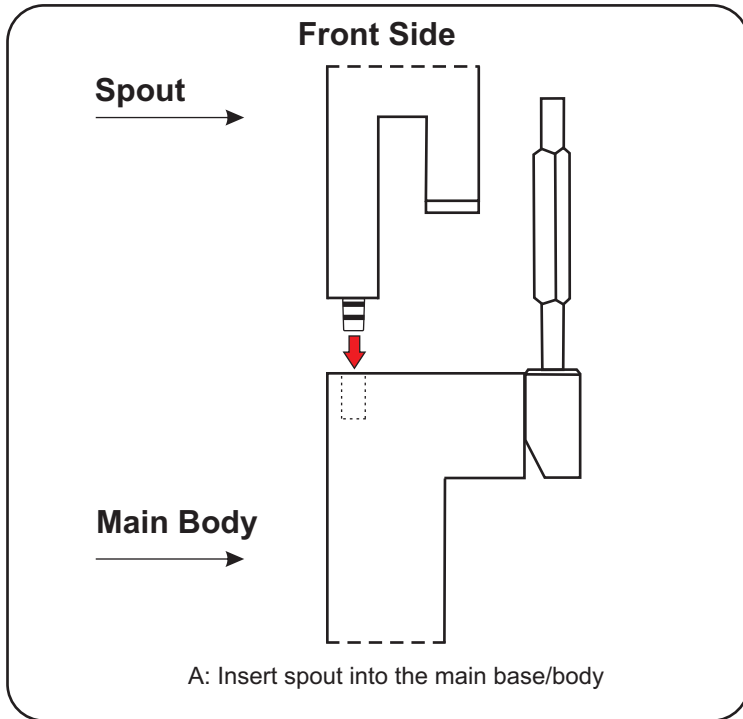

Step 2

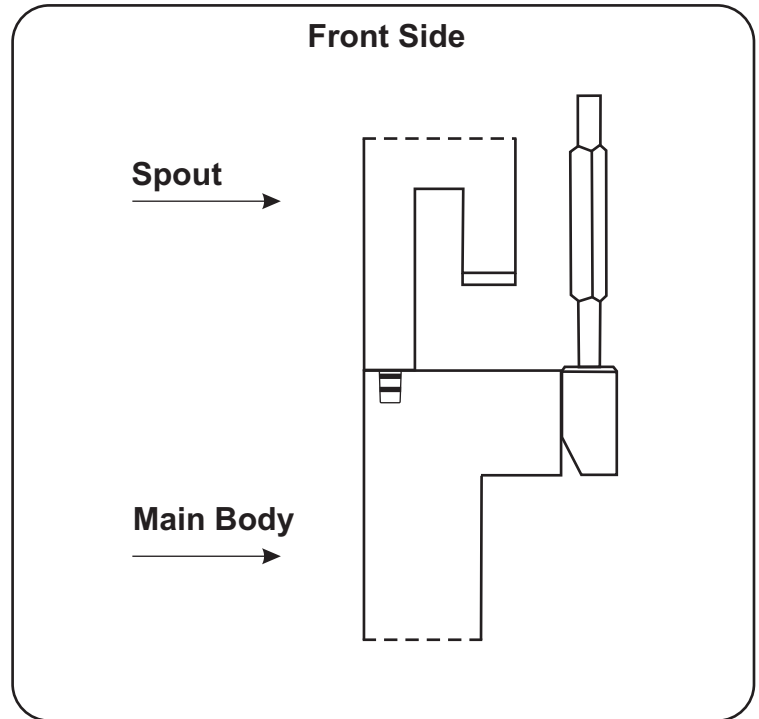

Step 3

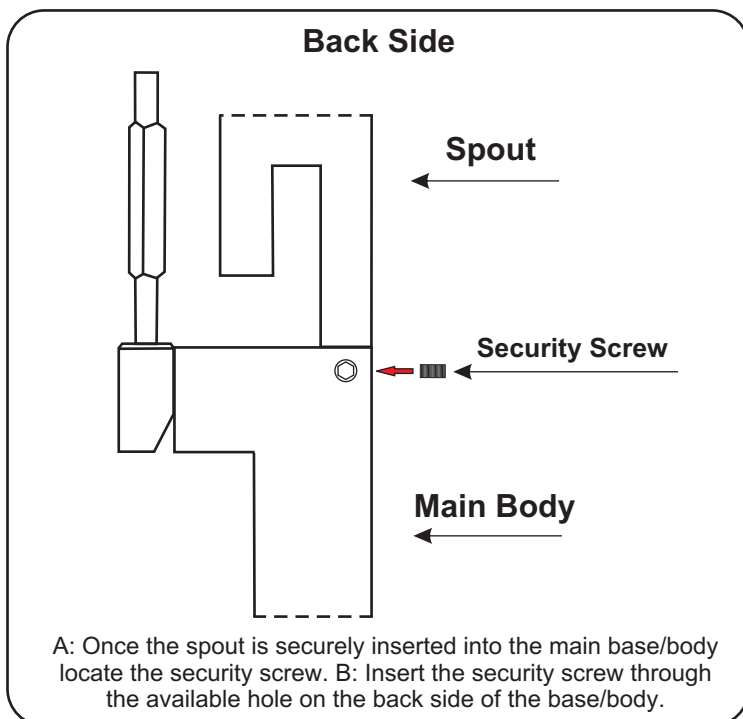

Step 4

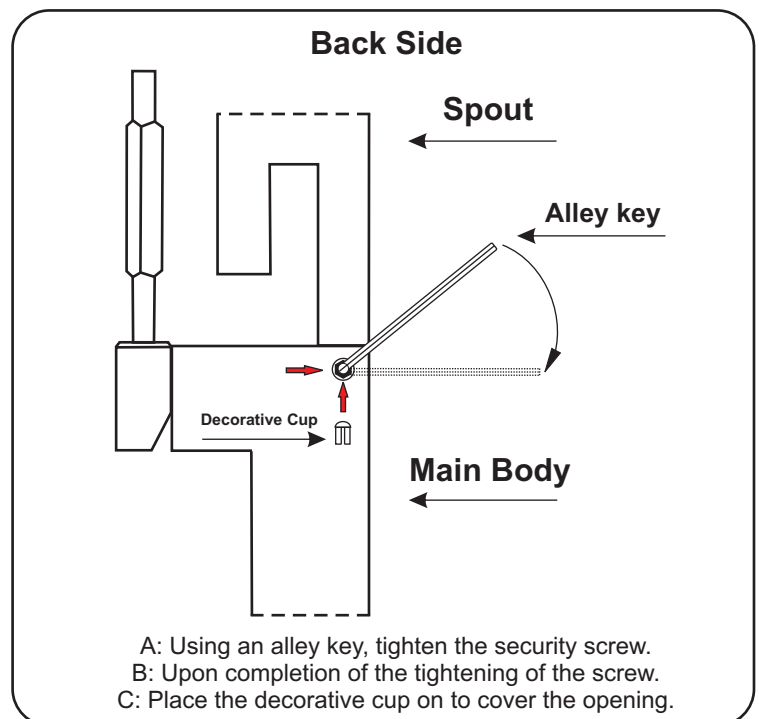

Installation

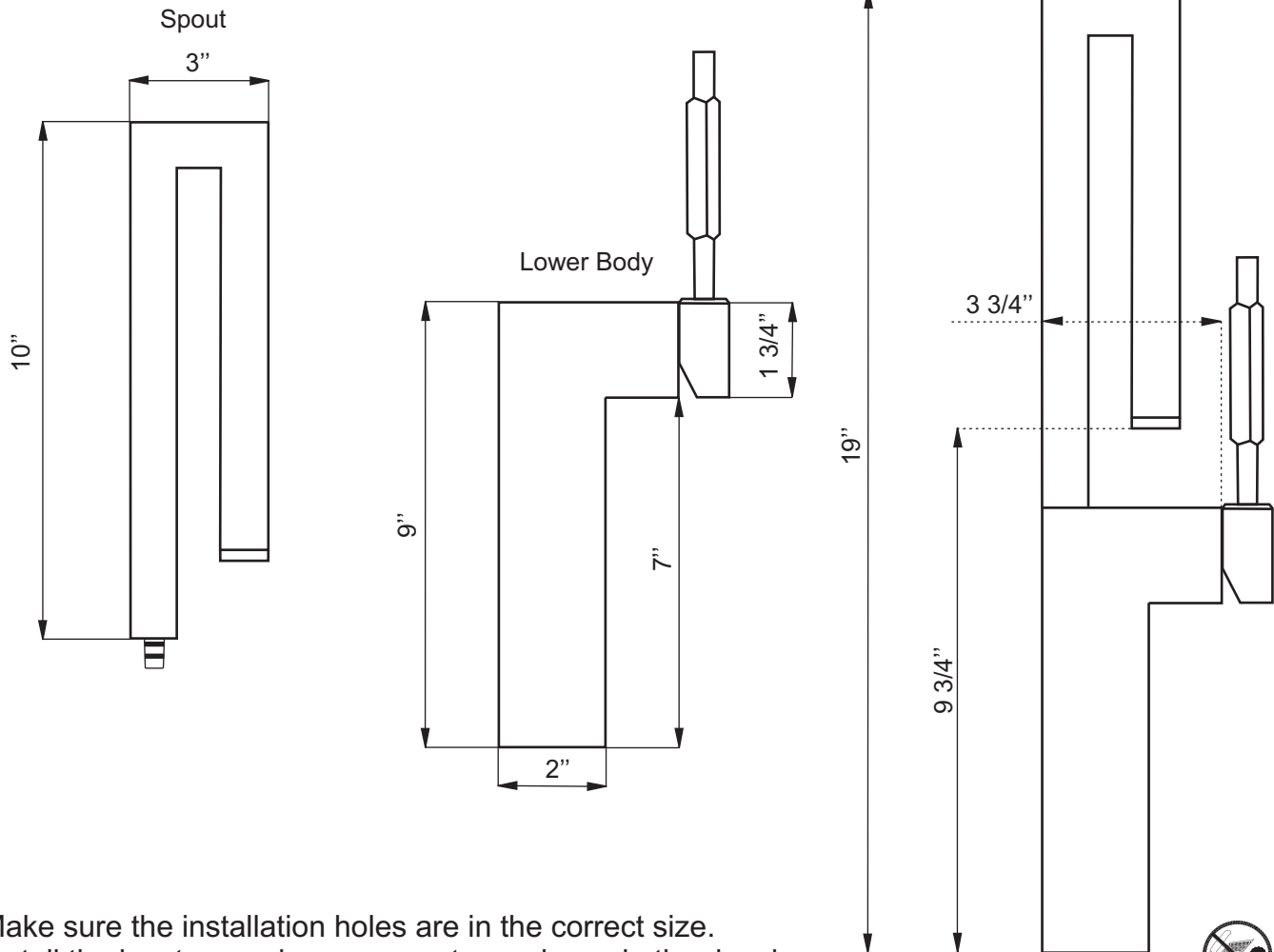

Make sure the installation holes are in the correct size.
 Install the lavatory and pop-up waste as shown in the drawing.
 Connect the main body and water supply pipe with water inlet pipe



Usage, Cleaning & Maintenance

Cleaning & Maintenance

1. Rinse with warm clean water and blot dry with a clean soft cloth only.
2. Never use any detergent, polisher, scraper or an abrasive cloth.
3. Do not use acid detergent.

Usage

1. Grab the handle and pull outward and to the right to open the faucet.
2. Push the handle back or away from you to increase cold