

LVR316-R

Low Voltage Mini-Recessed Downlight for Remodeling

Catalog No. _____

Type _____

Project _____

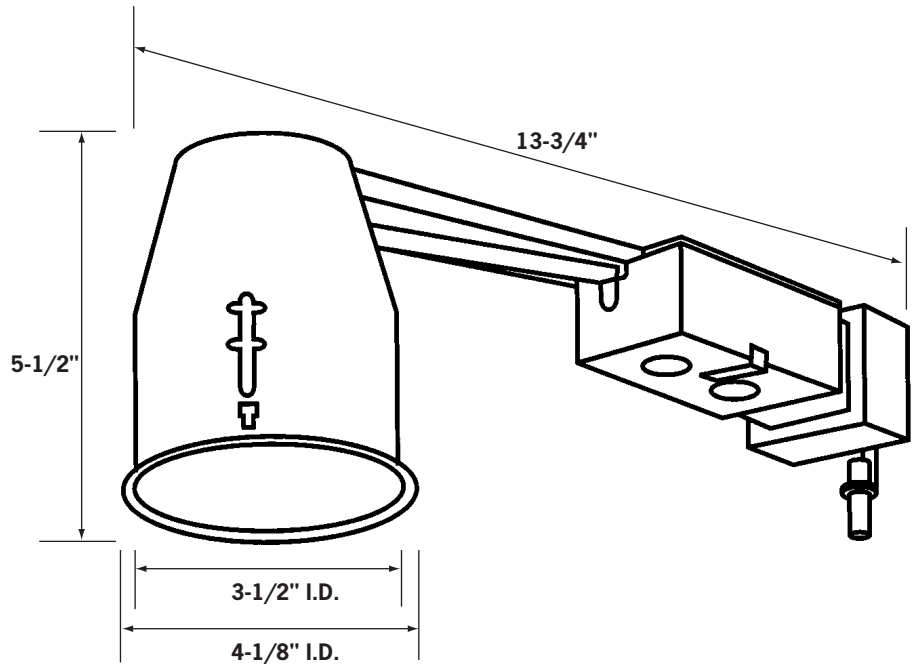

Ceiling Opening: 3-7/8"
Max. Ceiling Thickness: 1"

Specifications/Features

Housing

Low silhouette design for remodeling applications in solid or suspended ceilings.

Narrow fixture design for fast installation through ceiling opening minimizes remodeling mess.

Retractable mounting clips allow for easy installation into existing ceiling.

Lamp/Electrical

(1) 50W 12V MR16, GU5.3 base.

Class H in-line magnetic transformer is prewired and thermally protected. 120 V in/12V out. Conveniently mounted to end of J-Box and is replaceable to simplify future maintenance.

(6) 1/2" knock outs and spring latch access plates in J-box.

Can be used with low voltage, magnetic dimming controls for optimal control of illumination.

Ceramic terminal block socket.

Mounting

Fixture is easily installed through ceiling opening.

Retractable mounting clips lock fixture in place and adjust for different ceiling thicknesses from 1/2" to 1".

Trims

Baffle, multiplier, wall wash, accent and adjustable trim options available to suit a broad range of applications. See attached "Trims for 3" Low Voltage Recessed Housings" spec sheet for details.

Warranty

This fixture is covered by Con-Tech's full one year replacement guarantee after date of purchase.

Listing

cULus listed. Suitable for damp locations.

Ordering Information

Example Order:

LVR316-R

CTR312-P

HB-24

Housing/Voltage

LVR316-R - 120V/12V

Trims

For Trims, see attached "Trims for 3" Low Voltage Recessed Housings" spec sheet.

Options

CP - Chicago Plenum
CTR18-P - LV Monopoint Adapter
HB-24 - 27" Flat Hanger Set
HB-30 - Optional T-Bar Hanger Set
HBC-24 - 25" C-Channel Hanger Set
RL-KIT - Emergency battery backup for remote field installation



1-800-728-0312

www.con-techlighting.com

All specifications subject to change without notice.

Trims for 3" Low Voltage Recessed Housings

Catalog No. _____

Type _____

Project _____

General Trim Information

Maximum lamp rating for most trim options: 20-50W 12V MR-16 lamp, GU5.3 base.

*On fixtures designed for use with standard MR16 lamps, Con-Tech provides a clear tempered safety lens.

If use of MR16 with front glass is required, remove the factory provided clear tempered safety lens.

All trims have white trim finish unless specified.

All trims are cULus listed.

All trims are suitable for damp locations; only shower trims are listed for wet locations.

*See back for descriptions of Reflector/Trim Finish options.

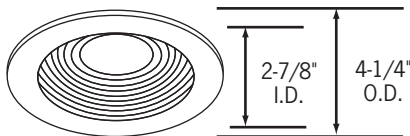

CTR301-P
Adjustable Black Baffle

CTR301-WHT
Adjustable White Baffle

15° Vertical swing, 45mm lens.

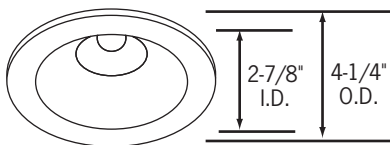

CTR302-P-(CLR, BLK, WHT)
Adjustable Multiplier, White Trim Ring, Select Reflector Finish

CTR302-(ST, NK)-CLR
Adjustable Multiplier, Select Metal Trim Finish, Clear Reflector

37° Vertical adjustment, 45mm lens.

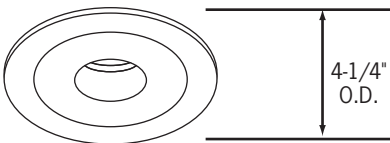

CTR305-BLK
Pin Spot, Black Cut-Off Reflector

CTR305-CLR
Pin Spot, Clear Cut-Off Reflector

Downlight Only, 50mm Lens

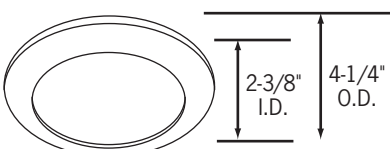

CTR311-(NK, P, ST)
Frosted Flat Glass

Shower light trim, double neoprene gasketed. cULus Listed for wet location.

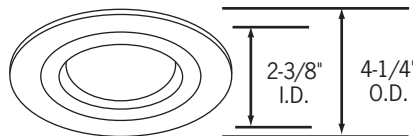

CTR312-P
Flat Glass
Etched Glass For Light Diffusion

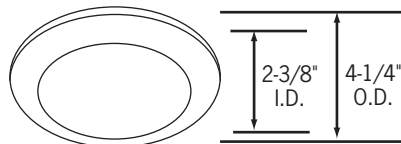

CTR313-P
Convex Drop Lens
Shower light trim. 3/4" Drop (ceiling to bottom of glass), double neoprene gasketed. cULus listed for wet location.

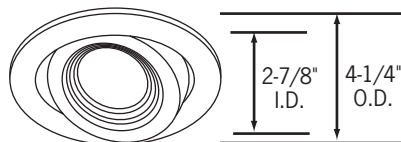

CTR306-P
Surface Adjustable Black Baffle
40° Vertical adjustment, 359° horizontal rotation. 50mm Lens. Regressed black baffle reduces surface brightness. Flat, stainless mounting clips hold trim firmly to ceiling.

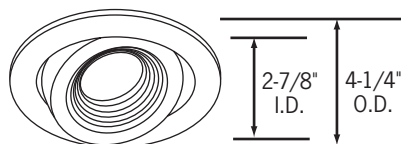

CTR307-(P, B, C, NK)
Adjustable Pin Spot, Black Baffle

CTR307-WHT
Adjustable Pin Spot, White Baffle
Deep baffle for maximum lamp concealment. May be used as a pin spot style downlight or an adjustable accent light. 35° Vertical adjustment. 45mm Lens.

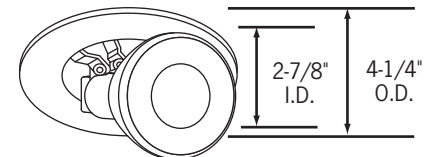

CTR320-(P, B, BC)
Retractable Pull Down

Black metal mesh ring surrounds lamp. Pull fixture straight down from trim and aim. Flood, Narrow Flood or Spot MR16 beam patterns available. Specify trim finish, 50mm Lens.

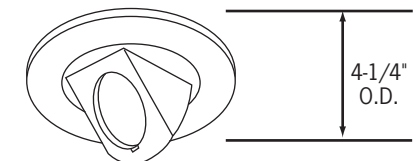

CTR324-(P, B, NK, CO, ST)
Fully Adjustable

Unsurpassed aiming flexibility: 87° vertical, 359° rotational. Front access, spring latch lamp retainer ring, black finish. Optional white finish available: **1623/224 WHITE**, ordered separately. Exclusive stainless flat springs insure firm, close-to-ceiling mounting. Accepts only one 47mm lens; if louver is required (FA-16 45MM), remove safety lens and use front glass MR16 lamp.

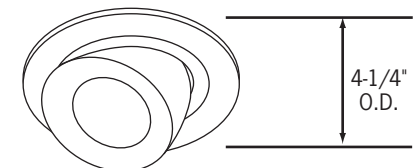

CTR325-(P, B, NK, S)
Fully Adjustable

Die cast, fully adjustable, round lampholder and backplate. Easy relamping with twist-off front retaining ring. Unsurpassed aiming flexibility: 87° vertical, 359° rotational. Specify trim finish, 50mm lens.

Continued on page 2



Trims for 3" Low Voltage Recessed Housings

Catalog No. _____

Type _____

Project _____

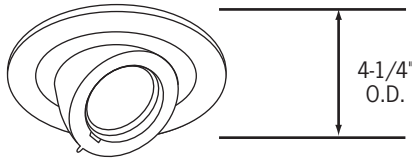

CTR335-(B, C, CO, NK, P, S)
Elbow

Exceptional aiming flexibility with 87° vertical, 359° rotation adjustment. Die-cast aluminum construction, wide selection of finishes. Front access, spring latch lamp retainer ring (black finish). Maximum depth from ceiling: 2-1/2". 47mm lens.

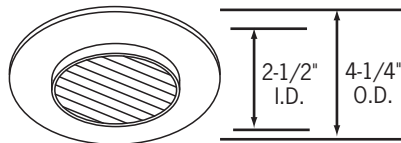

CTR316-BLK
Slotted Black Louver

CTR316-WHT
Slotted White Louver

Aluminum reflector. 360° Horizontal louver rotation to change illumination pattern. 50mm Lens.

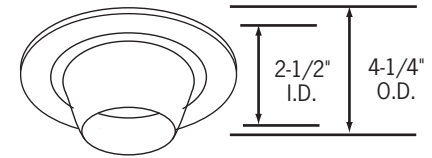

CTR318-B
Cobalt Blue Glass Cone

CTR318-F
White Frosted Glass Cone

Tapered glass diffuser, specular reflector. 1-1/4" Drop from ceiling. 50mm Lens.

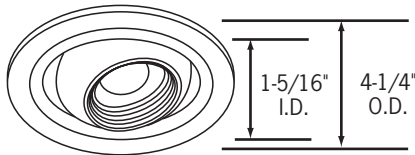

CTR308-P
Adjustable Classic Eyeball, Black Baffle

CTR308-WHT
Adjustable Classic Eyeball, White Baffle

Die cast aluminum. 45° Vertical adjustment, 358° horizontal rotation. 45mm Lens.

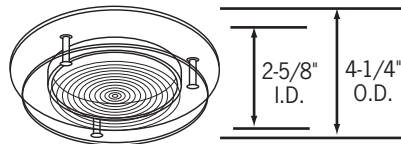

CTR315-(P, B, C)
Glass Accent

Floating glass panel (3-5/8" Dia.) with etched concentric rings. Clear, textured polycarbonate drop cylinder for minimum glare. 1-1/8" Drop from ceiling. Steel trim ring, specify finish. 50mm Lens.

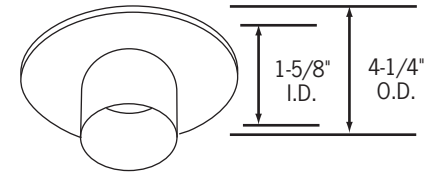

CTR321-B-(NK, P)
Cobalt Blue Glass Cylinder

CTR321-F-(NK, P)
Frosted Glass Cylinder

Clear upper reflector. 50mm Clear tempered safety lens. Cast aluminum trim construction. 1-1/4" Drop from ceiling.

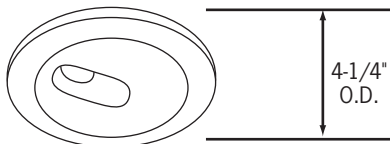

CTR303N-P
Slotted Wall Wash

50° Swing adjustment, external 358° rotation. Slot aperture permits maximum beam area adjustment for either wall wash or concealed accent lighting effects. Black interior surface, 45mm Lens.

1-3/8" x 2-1/2"
Oblong Slot



CTR317-P
Floating Ring

Decorative floating glass ring, 2" center opening. Clear reflector with diffuse plastic cone. 1-1/8" Drop from ceiling. Cast aluminum trim construction. 50mm Lens.

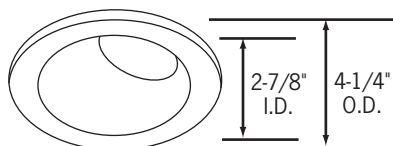

CTR304-P-CLR
Angled Wall Wash, Chrome Reflector

Adjustable lampholder with 55-75° aiming angle. 45mm Lens.

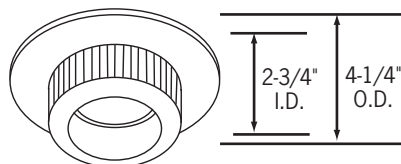

CTR310-B-(NK, P)
Cobalt Blue Glass

CTR310-F-(NK, P)
Frosted Glass

Must use Front Glass MR16 Lamp. 1-1/4" Drop from ceiling.

Reflector/Trim Finishes

Reflector Finish Options:

- CLR - Clear, Specular
- BLK - Black, Specular
- WHT - White Light, Specular

Trim Finish Options:

- P - White
- B - Black
- C - Chrome
- NK - Nickel
- BC - Black Chrome
- S - Silver UNLook
- CO - Brushed Copper
- ST - Brushed Stainless Steel



1-800-728-0312

www.con-techlighting.com

All specifications subject to change without notice.