

LVR316-IC

**Low Voltage
Recessed Downlight
for Insulated Ceiling
StopAire® Rated**

Catalog No. _____

Type _____

Project _____

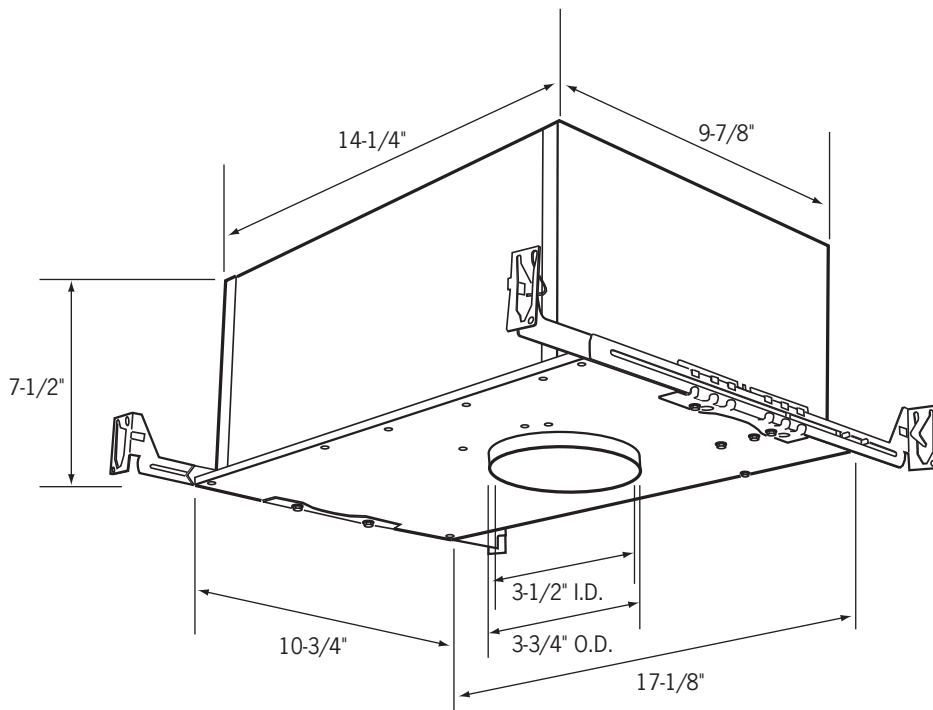

Ceiling Opening: 3-7/8"
Max. Ceiling Thickness: 1"

Specifications/Features

Housing

For insulated ceilings (solid or suspended) conforming to Washinton State Energy Code (WSEC) for low air infiltration.

StopAire® rated for Air-Tight Applications.

Fixture housing is removable through ceiling aperture for access to junction box.

"Sure-grip" spring permits inner housing to be lowered for adjustment to ceiling thickness.

Lamp/Electrical

(1) 12V 50W MR16; 50W max., GU5.3 base

Thermally protected Magnetic Class H Transformer is prewired, 120V in/12V out.

Junction Box has (4) 1/2" and (2) 3/4" knockouts with spring latch access plates.

Can be used with low voltage, magnetic dimming controls for optimal control of illumination.

Mounting

Dual extension hanger bars span from 15" to 25-1/4" with reversible placement feature. Hanger bars may be extended to rest on T-bar grid.

Trims

Wide selection of trim models available to suit the needs of economy, performance or decorative specifications. See attached "Trims for 3" Low Voltage Recessed Housings" spec sheet for selection and details.

Warranty

This fixture is covered by Con-Tech's full one year replacement guarantee after date of purchase.

Listing

cULus listed. Suitable for damp locations.

Ordering Information

Example Order: - -

Housing

LVR316-IC

Trims

For Trims, see attached "Trims for 3" Low Voltage Recessed Housings" spec sheet.

Options

CTR18-P - LV Monopoint Adapter
HB-24 - 27" Flat Hanger Set
HB-30 - Optional T-Bar Hanger Set
HBC-24 - 25" C-Channel Hanger Set
RL-KIT - Emergency battery backup for remote field installation



1-800-728-0312

www.con-techlighting.com

All specifications subject to change without notice.

Trims for 3" Low Voltage Recessed Housings

Catalog No. _____

Type _____

Project _____

General Trim Information

Maximum lamp rating for most trim options: 20-50W 12V MR-16 lamp, GU5.3 base.

*On fixtures designed for use with standard MR16 lamps, Con-Tech provides a clear tempered safety lens.

If use of MR16 with front glass is required, remove the factory provided clear tempered safety lens.

All trims have white trim finish unless specified.

All trims are cULus listed.

All trims are suitable for damp locations; only shower trims are listed for wet locations.

*See back for descriptions of Reflector/Trim Finish options.

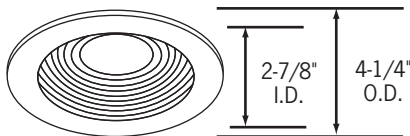

CTR301-P
Adjustable Black Baffle

CTR301-WHT
Adjustable White Baffle
15° Vertical swing, 45mm lens.

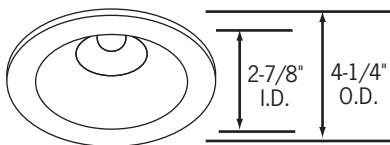

CTR302-P-(CLR, BLK, WHT)
Adjustable Multiplier, White Trim Ring, Select Reflector Finish

CTR302-(ST, NK)-CLR
Adjustable Multiplier, Select Metal Trim Finish, Clear Reflector
37° Vertical adjustment, 45mm lens.

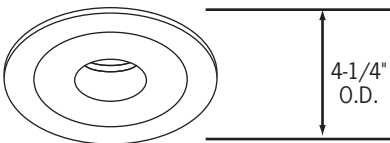

CTR305-BLK
Pin Spot, Black Cut-Off Reflector

CTR305-CLR
Pin Spot, Clear Cut-Off Reflector
Downlight Only, 50mm Lens

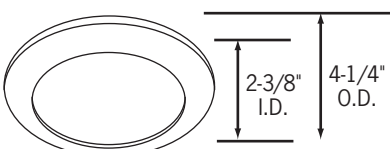

CTR311-(NK, P, ST)
Frosted Flat Glass
Shower light trim, double neoprene gasketed. cULus Listed for wet location.

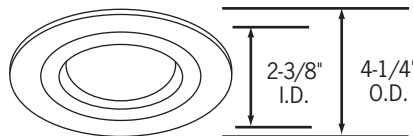

CTR312-P
Flat Glass
Etched Glass For Light Diffusion

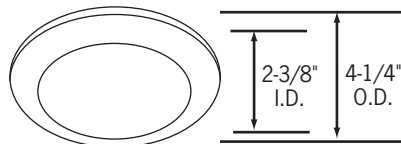

CTR313-P
Convex Drop Lens
Shower light trim. 3/4" Drop (ceiling to bottom of glass), double neoprene gasketed. cULus listed for wet location.

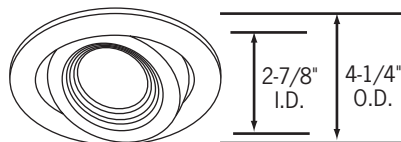

CTR306-P
Surface Adjustable Black Baffle
40° Vertical adjustment, 359° horizontal rotation. 50mm Lens. Regressed black baffle reduces surface brightness. Flat, stainless mounting clips hold trim firmly to ceiling.

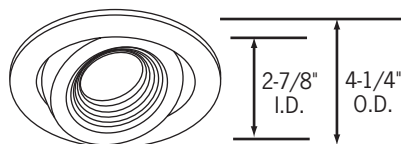

CTR307-(P, B, C, NK)
Adjustable Pin Spot, Black Baffle

CTR307-WHT
Adjustable Pin Spot, White Baffle
Deep baffle for maximum lamp concealment. May be used as a pin spot style downlight or an adjustable accent light. 35° Vertical adjustment. 45mm Lens.

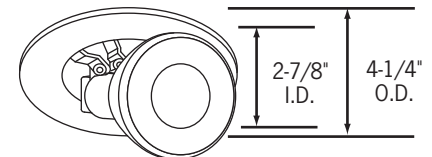

CTR320-(P, B, BC)
Retractable Pull Down
Black metal mesh ring surrounds lamp. Pull fixture straight down from trim and aim. Flood, Narrow Flood or Spot MR16 beam patterns available. Specify trim finish, 50mm Lens.

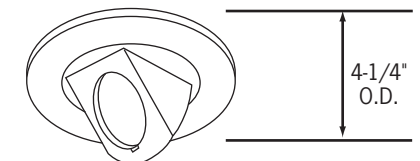

CTR324-(P, B, NK, CO, ST)
Fully Adjustable
Unsurpassed aiming flexibility: 87° vertical, 359° rotational. Front access, spring latch lamp retainer ring, black finish. Optional white finish available: **1623/224 WHITE**, ordered separately. Exclusive stainless flat springs insure firm, close-to-ceiling mounting. Accepts only one 47mm lens; if louvers is required (FA-16 45MM), remove safety lens and use front glass MR16 lamp.

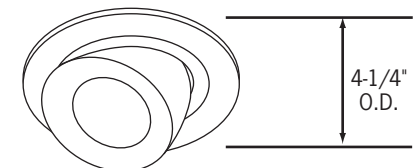

CTR325-(P, B, NK, S)
Fully Adjustable
Die cast, fully adjustable, round lampholder and backplate. Easy relamping with twist-off front retaining ring. Unsurpassed aiming flexibility: 87° vertical, 359° rotational. Specify trim finish, 50mm lens.

Continued on page 2



Trims for 3" Low Voltage Recessed Housings

Catalog No. _____

Type _____

Project _____

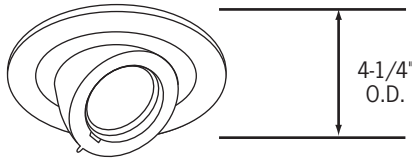

CTR335-(B, C, CO, NK, P, S)
Elbow

Exceptional aiming flexibility with 87° vertical, 359° rotation adjustment. Die-cast aluminum construction, wide selection of finishes. Front access, spring latch lamp retainer ring (black finish). Maximum depth from ceiling: 2-1/2". 47mm lens.

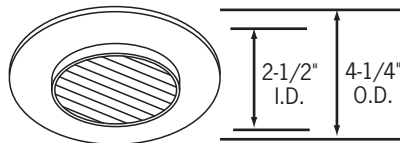

CTR316-BLK
Slotted Black Louver

CTR316-WHT
Slotted White Louver

Aluminum reflector. 360° Horizontal louver rotation to change illumination pattern. 50mm Lens.

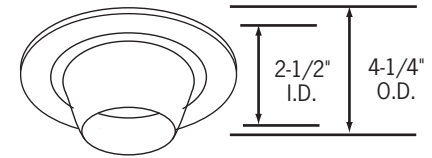

CTR318-B
Cobalt Blue Glass Cone

CTR318-F
White Frosted Glass Cone

Tapered glass diffuser, specular reflector. 1-1/4" Drop from ceiling. 50mm Lens.

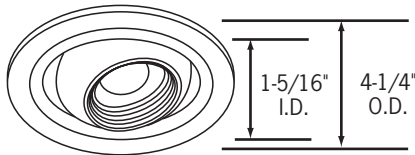

CTR308-P
Adjustable Classic Eyeball, Black Baffle

CTR308-WHT
Adjustable Classic Eyeball, White Baffle

Die cast aluminum. 45° Vertical adjustment, 358° horizontal rotation. 45mm Lens.

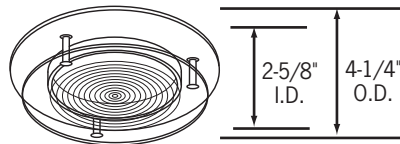

CTR315-(P, B, C)
Glass Accent

Floating glass panel (3-5/8" Dia.) with etched concentric rings. Clear, textured polycarbonate drop cylinder for minimum glare. 1-1/8" Drop from ceiling. Steel trim ring, specify finish. 50mm Lens.

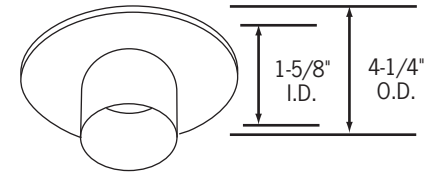

CTR321-B-(NK, P)
Cobalt Blue Glass Cylinder

CTR321-F-(NK, P)
Frosted Glass Cylinder

Clear upper reflector. 50mm Clear tempered safety lens. Cast aluminum trim construction. 1-1/4" Drop from ceiling.

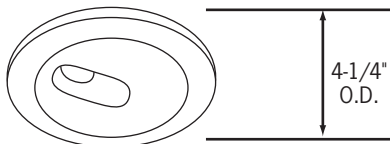

CTR303N-P
Slotted Wall Wash

50° Swing adjustment, external 358° rotation. Slot aperture permits maximum beam area adjustment for either wall wash or concealed accent lighting effects. Black interior surface, 45mm Lens.

1-3/8" x 2-1/2"
Oblong Slot

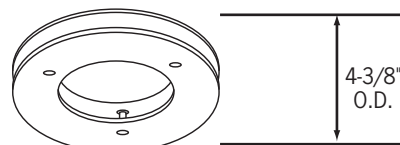

CTR317-P
Floating Ring

Decorative floating glass ring, 2" center opening. Clear reflector with diffuse plastic cone. 1-1/8" Drop from ceiling. Cast aluminum trim construction. 50mm Lens.

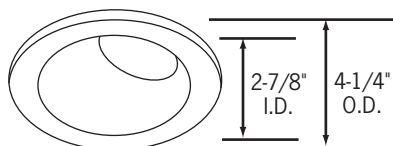

CTR304-P-CLR
Angled Wall Wash, Chrome Reflector

Adjustable lampholder with 55-75° aiming angle. 45mm Lens.

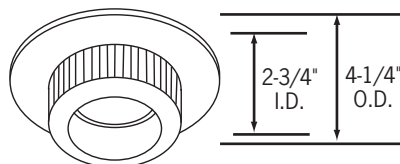

CTR310-B-(NK, P)
Cobalt Blue Glass

CTR310-F-(NK, P)
Frosted Glass

Must use Front Glass MR16 Lamp. 1-1/4" Drop from ceiling.

Reflector/Trim Finishes

Reflector Finish Options:

- CLR - Clear, Specular
- BLK - Black, Specular
- WHT - White Light, Specular

Trim Finish Options:

- P - White
- B - Black
- C - Chrome
- NK - Nickel
- BC - Black Chrome
- S - Silver UNLook
- CO - Brushed Copper
- ST - Brushed Stainless Steel



1-800-728-0312

www.con-techlighting.com

All specifications subject to change without notice.