

LVR16-TH

50W Low Voltage Recessed Downlight for New Construction

Catalog No. _____

Type _____

Project _____

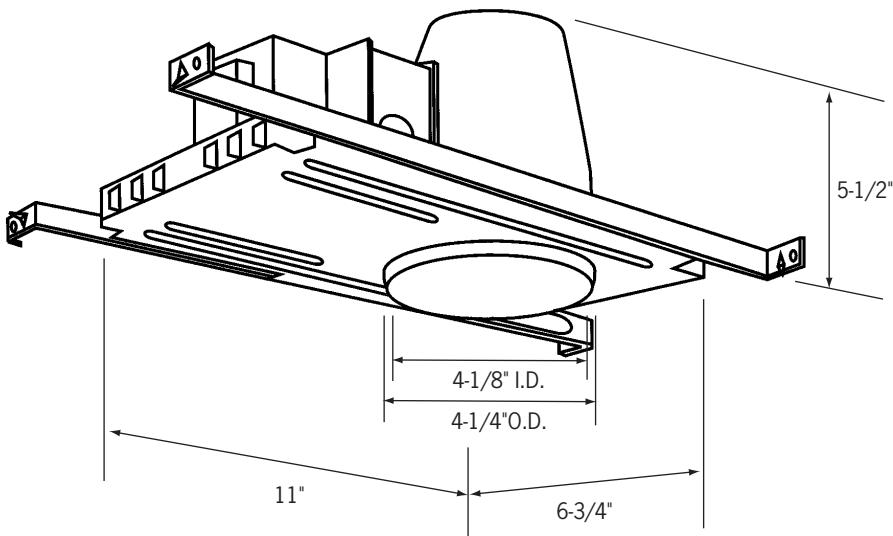

Ceiling Opening: 4-3/8"
Max. Ceiling Thickness: 1-5/8"

Specifications/Features

Housing

New Construction housing for use in any type of ceiling application. Lamp housing is removable through ceiling aperture for access to junction box.

"Sure-grip" springs permit housing to be lowered and precisely adjust to ceiling thicknesses from 1/2" to 1-5/8".

For insulated ceilings, maintain a 3" clearance around fixture.

Lamp/Electrical

(1) 50W 12V MR16, GU5.3 base.

Porcelain socket assembly with Molex connector.

Magnetic Class H transformer with Molex disconnect in J-box is fully dimmable with magnetic low voltage dimmers.

Transformer has internal thermal protection.

J-box approved for through circuit wiring; (3) 1/2" knockouts, (1) 3/4" knockout and (1) concentric 1/2" & 3/4" knockout with spring latch access plates.

120V Transformer Ratings:

Input: 120VAC, 60Hz, .54A, 65VA; Output: 12VAC, 60Hz, 4.2A, 50W

277V Transformer Ratings:

Input: 277VAC, 60Hz, .24A, 65VA; Output: 12VAC, 60Hz, 4.2A, 50W

Mounting

Dual extension hanger bars span from 15" to 25-1/4" with reversible placement feature.

Hanger bars may be extended to rest on T-bar grid.

Trims

Baffle, multiplier, wall wash, accent and adjustable trim options available to suit a broad range of applications. See attached "Trims for 4" Low Voltage Recessed Housings" spec sheet for details.

Warranty

This fixture is covered by Con-Tech's full one year replacement guarantee after date of purchase.

Transformer has a one (1) year warranty.

Listing

cULus listed. Suitable for damp locations.

New York City approved, calendar number 40179.

Ordering Information

Example Order:

Housing/Voltage

LVR16-TH - 120V/12V
LVR16-TH 277V - 277V/12V

Trims

For Trims, see attached "Trims for 4" Low Voltage Recessed Housings" spec sheet.

Options

CP - Chicago Plenum
CTR18-P - LV Monopoint Adapter
HB-24 - 27" Flat Hanger Set
HBC-24 - 25" C-Channel Hanger Set
RL-KIT - Emergency battery backup for remote field installation



1-800-728-0312

www.con-techlighting.com

All specifications subject to change without notice.

Trims for 4" Low Voltage Recessed Housings

Catalog No. _____

Type _____

Project _____

All trims are compatible with **4" Low Voltage Recessed Housings** (LVR16 and LVR1675 Series).

Max. Lamp: (1) 20 - 50W MR16 lamp, GU5.3 base unless noted.

On fixtures designed for use with standard MR16 lamps, Con-Tech provides a clear tempered safety lens. If use of MR16 with front glass is required, remove the factory provided clear tempered safety lens.

All trims have white trim finish unless specified.

All trims are cULus listed and are suitable for damp locations; only shower trims are listed for wet locations.

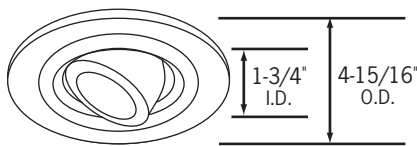

CTR1606-(B, P)

Surface Adjustable
45° max. vertical and 359° rotational aiming.
Die-cast aluminum construction. 50mm lens.
Front access for re-lamping.



Slotted Wall Wash

Standard Trim, 5-1/2" O.D.

CTR1603-P

Narrow Trim, 4-15/16" O.D.

CTR1603N-P

Cast Aluminum Trim, 5-1/8" O.D.

CTR1603-PA

Slot aperture permits maximum beam area adjustment for either wall wash or concealed accent lighting effects. 50° swing adjustment, 358° rotation. 50mm lens.

75W lamp may be used with LVR1675-TH and LVR1675-TR housings.

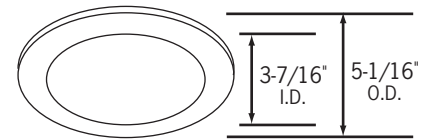

CTR1611FR-(NK, P, ST)

Flat Frosted Glass Shower Light

CTR1611CL-(NK, P, ST)

Flat Clear Glass Shower Light

Die cast aluminum. Double neoprene gasketed. Clear specular reflector. cULus listed for wet locations.

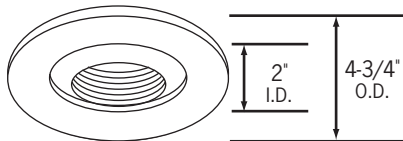

CTR1607-(B, C, P)

Adjustable Pin Spot, Black Baffle*

CTR1607-P-WHT

Adjustable Pin Spot, Black Baffle*

Low profile gimbal design for aiming flexibility. 35° swing adjustment. 50mm lens.

75W lamp may be used with LVR1675-TH and LVR1675-TR housings.

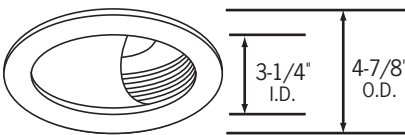

CTR1613-P

Black Baffled Scoop Wall Wash, 50mm Lens

CTR1613-P-WHT

White Baffled Scoop Wall Wash, 50mm Lens

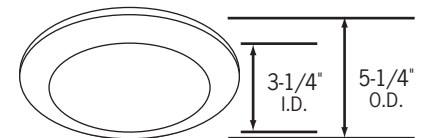

CTR1616FR-(NK, P, ST)

Convex Frosted Glass Shower Light

Die cast aluminum. Double neoprene gasketed. Clear specular reflector. cULus listed for wet locations. Depth From Ceiling: 3/4"

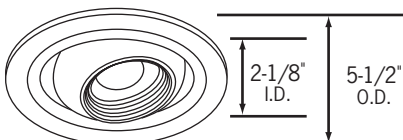

CTR1608-P

Black Baffled Eyeball

45° vertical aiming, 358° rotational adjustment. Black baffle provides excellent cutoff and lamp concealment. 50mm lens.

75W lamp may be used with LVR1675-TH and LVR1675-TR housings.

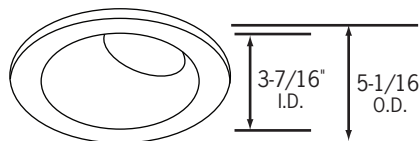

CTR1614-P

Black Baffled Angled Wall Wash

CTR1614-P-CLR

White Baffled Angled Wall Wash

Adjustable lampholder; 55-75° aiming angle. 45mm lens.

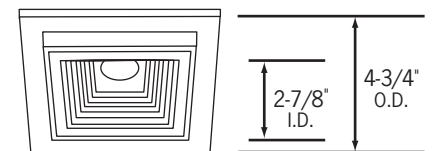

CTR1604-P

Black Baffled Square

Deep baffle traps stray light and conceals light source. Downlight or adjustable-up to 35° vertical adjustment. 50mm lens.

75W lamp may be used with LVR1675-TH and LVR1675-TR housings.

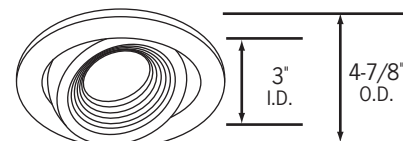

CTR1609-P

Surface Adjustable, Cast Black Baffle

CTR1609-P-WHT

Surface Adjustable, Cast White Baffle

Low glare baffle. May be used as a downlight or adjustable accent light with up to 35° vertical and 358° rotational adjustment. 50mm lens.

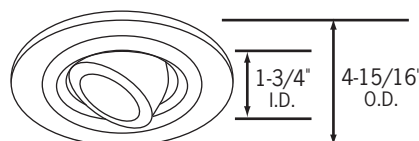

CTR1606-(B, P)

Surface Adjustable

45° max. vertical and 359° rotational aiming. Die-cast aluminum construction. 50mm lens. Front access for re-lamping.

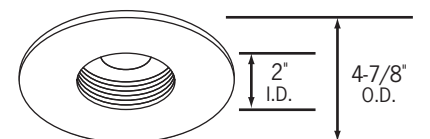

CTR1605-P

Black Baffled Pin Spot

CTR1605-P-WHT

White Baffled Pin Spot

Precise beam spread and unobtrusive appearance. Concealed lamp design for maximum eye comfort. Deep baffle. Will hold (2) lenses or louvers, (1) 47mm size on the bottom, (1) 50mm size on the top.



1-800-728-0312

www.con-techlighting.com

All specifications subject to change without notice.

Continued

Trims for 4" Low Voltage Recessed Housings, Con't.

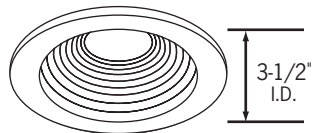

Baffled Downlight*

Standard Trim, 5-1/2" O.D.

CTR1601-P

Adjustable Black Baffle

CTR1601-P-WHT

Adjustable White Baffle

Narrow Trim, 4-15/16" O.D.

CTR1601N-P

Adjustable Black Baffle

CTR1601N-P-WHT

Adjustable White Baffle

Cast Aluminum Trim, 5-1/8" O.D.

CTR1601-PA

Adjustable Black Baffle

CTR1601-PA-WHT

Adjustable White Baffle

CTR1601-BA

Black Baffle, Black Cast Aluminum Trim Ring

Deep ballfe traps stray light and conceals lamp. May be used as downlight or adjustable accent light with 60° swing adjustment. May be used with multiple light controlling elements, 50mm lens.

75W lamp may be used with LVR1675-TH and LVR1675-TR housings.

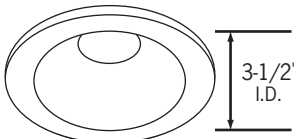

Multiplier*

Standard Trim, 5-1/2" O.D.

CTR1602-P-(BLK, CLR, GLD, WHT)

Adjustable Multiplier, White Trim Ring, Select Reflector Finish

CTR1602-(ST, NK)-CLR

Adjustable Multiplier, Select Metal Trim Finish, Clear Reflector

Narrow Trim, 4-15/16" O.D.

CTR1602N-P-(BLK, CLR, GLD, WHT)

Cast Aluminum Trim, 5-1/8" O.D.

CTR1601-PA-(BLK, CLR, WHT)

Utilizes a highly polished, specular reflector to maximize light intensity while concealing the light source. Offers the flexibility to be used as a downlight or adjustable accent light with 35° swing adjustment. May be used with multiple light controlling elements, 50mm lens.

75W lamp may be used with LVR1675-TH and LVR1675-TR housings.

*NOTE: These trims use a stepped lens holder design. Insert 45mm lens on lower level of adjustable lamp seat, install 50mm lens on higher position.



CTR1624-

(B, BC, C, CO, NK, P, PB, ST)**

Fully Adjustable Square in Round

87° vertical and 359° rotation adjustment. Die-cast aluminum construction. Front access, spring latch lamp retainer ring (black finish). 47mm lens. Depth from ceiling: 2-1/2"

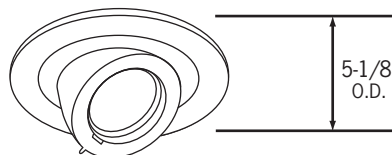

CTR1625-(B, BC, NK, P)**

Fully Adjustable Round/Round

87° vertical and 359° rotation adjustment. Die-cast aluminum construction. Front access, spring latch lamp retainer ring (black finish). 47mm lens. Depth From Ceiling: 2-1/2"

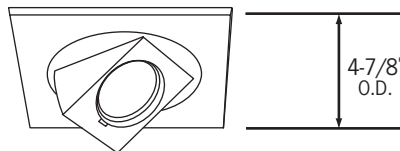

CTR1629-(B, BC, NK, P)**

Fully Adjustable Square/Square

87° vertical and 359° rotation adjustment. Die-cast aluminum construction. Front access, spring latch lamp retainer ring (black finish). 47mm lens. Depth From Ceiling: 2-5/8"

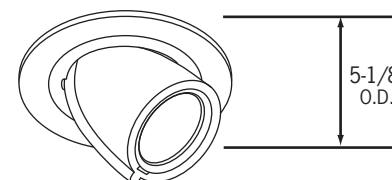

CTR1635-(B, C, NK, P)**

Fully Adjustable Round/Round

87° vertical and 359° rotation adjustment. Die-cast aluminum construction. Front access, spring latch lamp retainer ring (black finish). 47mm lens. Depth From Ceiling: 2-3/4"

**NOTE: Order part number SOCKET 1624/75 to convert these fully adjustable trims for 75W housings. Black finish retainer ring standard. Order part number 1623/24 WHITE for white retainer ring. These fully adjustable trims will only accept one lens. If a FA-16 45MM louver is required, remove the safety lens and use a front glass MR16 lamp. A series of 47mm tempered color or light controlling lenses may be used instead of the clear lens supplied.

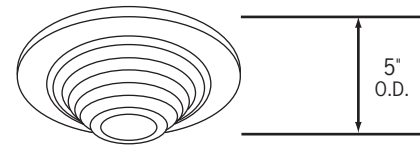

CTR1618-B

Blue Compressed Glass

CTR1618-F

Frosted Compressed Glass

Full lamp concealment. Must use front glass MR16 lamp. 1-1/2" inner diameter.

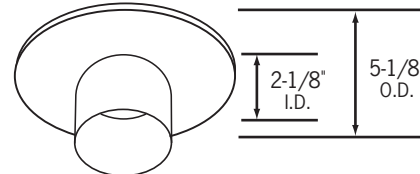

CTR1621CB-(NK, P)

Blue Glass Cylinder

CTR1621FR-(NK, P)

Frosted Glass Cylinder

Cylindrical glass diffuser with specular reflector focuses light downward and eliminates glare. Depth From Ceiling: 2"

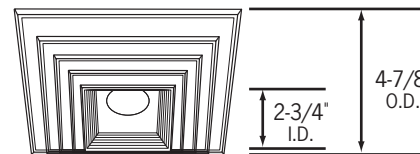

CTR1612-(C, P)

Die Cast Square with Black Baffle

Die cast stepped square trim, deep black baffle for full lamp concealment. 50mm lens.

75W lamp may be used with LVR1675-TH and LVR1675-TR housings.

Reflector/Trim Finishes

Reflector Finish Oions:

CLR - Clear, Specular

GLD - Gold, Specular

BLK - Black, Specular

WHT - White Light, Specular

Trim Finish Options:

P - White

B - Black

C - Chrome

NK - Nickel

BC - Black Chrome

S - Silver UNLook

CO - Brushed Copper

ST - Brushed Stainless Steel



1-800-728-0312

www.con-techliting.com

All specifications subject to change without notice.