

10 YEAR MANUFACTURER'S  
LIMITED WARRANTY

All parts of this Galleria Home Products faucet are warranted to the original retail purchaser to be free from defects in material and workmanship for a period of Ten(10) years from the date of purchase as shown on the purchaser's receipt.

This warranty is limited to defective parts only, labor charges and/or damage resulting from improper installation, repair or replacements, as well as incidental and consequential damages connected therewith are excluded.

Any damage to this faucet as a result of misuse, abuse, neglect, accident, or improper installation or any use not consistent with the instructions furnished by us, will void this warranty.

Replacement parts can be obtained from your local dealer. Freight cost is not covered by Manufacture.

**CAUTION!!!**

1. Water lines must be completely flushed before use, to avoid debris & clogs in your water system leading to mal-function and reduction of water flow.
2. Warranty to be void if water lines are not flushed before use of new faucet.
3. Use of abrasives of any strength may damage the finish of your faucet and void this warranty.

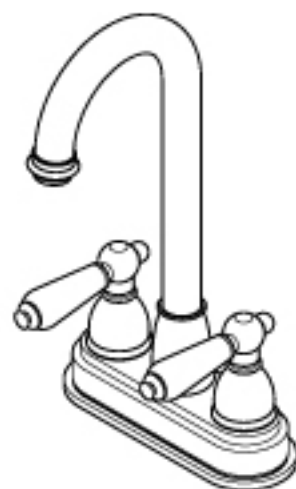
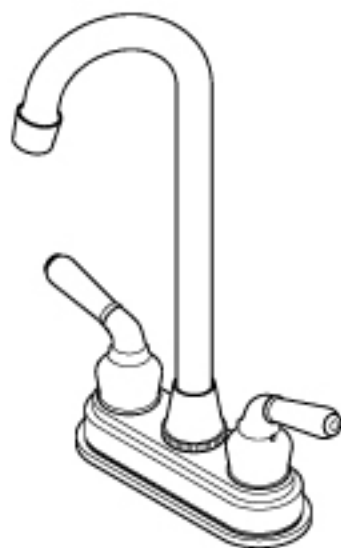

## INSTALLATION INSTRUCTIONS

For Use With Galleria's Heritage Twin-Handle Bar Faucets

- NOTE: 1. USE TEFLON TAPE ON ALL THREADED CONNECTIONS  
2. FLUSH LINE BEFORE FAUCET INSTALLATION TO REMOVE DEBRIS IN LINES.  
3. NO PLUMBER'S PUTTY ON ANY FINISH TO CORRODE FINISH OF FAUCET SURFACE.

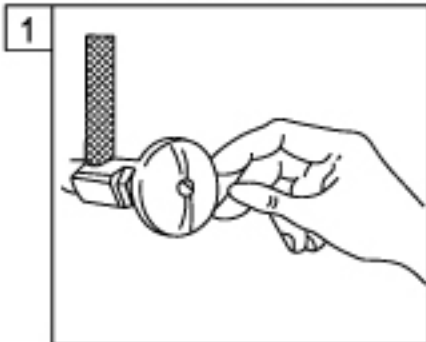
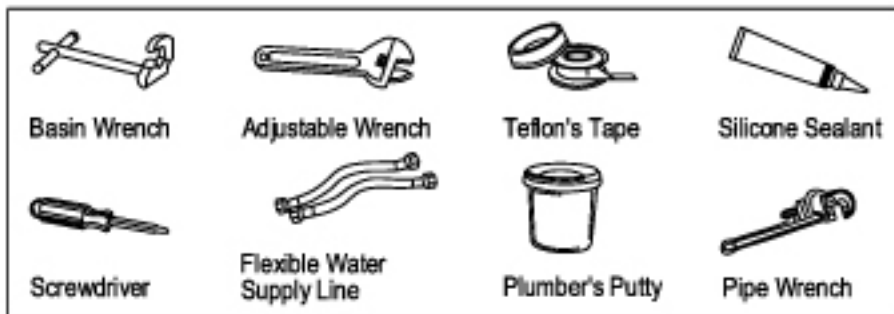

1. Shut off hot and cold water supply under sink. Plug sink drain with cloth to avoid losing small parts. Remove old faucet.

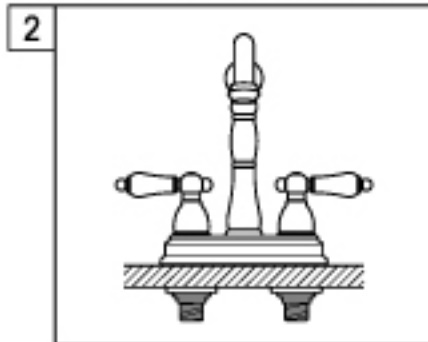

2. Set the faucet in place, insert the inlet shanks through the sink holes, and press down. Assemble the washers and locknuts on the inlet shanks, and then tighten the nuts with hand.

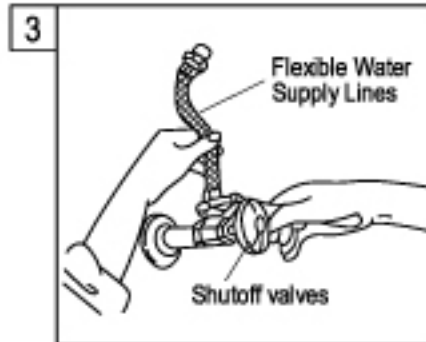

3. Connect the water supply lines. Before connecting the supply lines, apply pipe joint compound to the threads on the inlet shanks and shut off valves with an adjustable wrench.

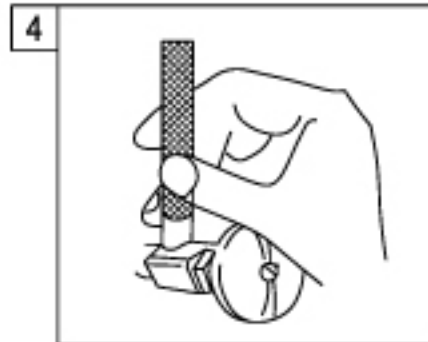

4. Turn on water supply valves and check for leaks, especially at hook-ups to supply lines.

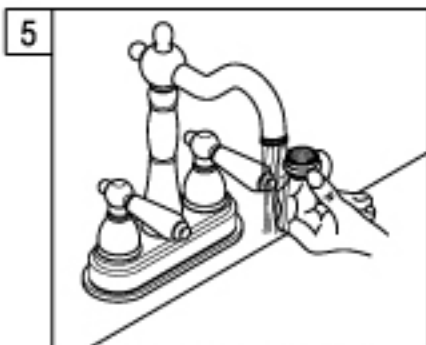

5. Remove the aerator before turning on your new faucet for the first time. This is to prevent any deposits from clogging your aerator. Allow both hot and cold water to run for one minute. Replace aerator.