

HALO®

**H5ICAT**

5" Aperture
IC AIR-TITE Housing
120V Line Voltage

RECESSED DOWNLIGHTING

- Thermally Protected IC Housing
- Housing may be covered with insulation
- AIR-TITE™ housing prevents airflow between attic and living areas
- For use with 120V Incandescent lamps

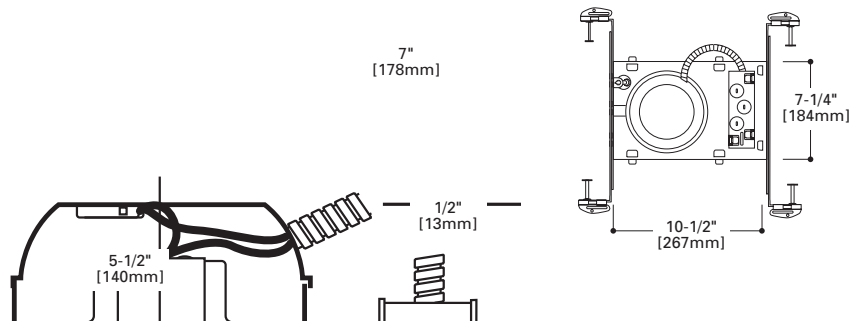
**DIMENSIONS****DESCRIPTION**

The Halo H5 series utilizes a nominal 5" aperture designed to accommodate smaller sized PAR20 and PAR30 halogen lamps. The wide variety of trims available allows a number of different lighting effects to be created with one basic housing.

Housing

- Die-stamped 20 gauge aluminum.
- Air-Tite gasket supplied with housing to complete ATM-E283 installation
- Spare 6-pack Air-Tite Gasket available (GA-ATH5-6PK)

Plaster Frame

Galvanized steel construction. The housing can be removed from plaster frame to provide access to the junction box. Plaster frame features include:

- Regressed locking screw for securing hanger bars
- Cutouts for easily crimping hanger bars in position
- Halo name embossed on plaster frame

Slide-N-Side™ Junction box

- UL Listed for through branch circuit wiring (maximum 8 No.12 ga., 90°C conductors).
- 1/2" trade size conduit knockouts with true pry-out slots positioned to accommodate straight conduit runs.
- Slide-N-Side™ wire traps allow non-metallic sheathed cable to be installed without tools and

without removing knockouts.

- Accepts a wide range of non-metallic sheathed cable.
- Allows wiring connections to be made outside the junction box
- Simply insert the cable directly into the trap after connections are made.
- Accommodates the following standard non-metallic sheathed cable sizes:

(US) #14/2, #14/3, #12/2, #12/3
(Canada) #14/2, #14/3, #12/2

GOT NAIL! Pass-N-Thru™ Bar Hangers.

- Pre-installed nail easily installs in regular lumber, engineered lumber and laminated beams.
- Score lines allow "toolless" shortening for 12" joists.
- Bar hangers can be repositioned 90° on plaster frame
- Safety and guidance system prevents snagging, ensures smooth straight nail penetration and allows bar hangers to be easily removed if necessary.
- Automatic levelling flange aligns the housing and lets you hold the housing in place with one hand while driving nails.
- Housing can be positioned at any point within 24" joist span
- Pass-N-Thru™ feature allows bar hangers to be shortened without removing from plaster frame.
- Integral T-bar clip snaps onto T-bars - no additional clips required.

Socket

Porcelain socket with nickel plated brass screw shell, snaps into trim for consistent lamp positioning. Shipping insert protects socket from overspray.

Thermal Protector

Self resetting thermal protector deactivates fixture if overheating occurs due to improper lamping.

Trims

- Housing accommodates a wide range of Halo 5" trims. Torsion springs on all trims for quick and easy installation.
- Fixed socket bracket aligns socket for consistent lamp position.

Labels

- UL/cUL listed
 - Damp Location Listed
 - UL/cUL listed for Feed Through
 - UL/cUL listed for Direct Contact with Insulation and combustible material
- Meets following requirements:
- Washington State Energy Code
 - International Energy Conservation Code (IECC)
 - State of California Title 24 Low Efficacy Luminaire IC and AT requirement
 - New York State Energy Conservation Construction Code
 - Certified under ASTM-E283 for air tight construction.

**GA-ATH5-6PK**

6-pack H5ICAT Air-Tite™ gaskets

A housing gasket is the final step in completing an air-tight, code-compliant installation. Halo makes this final step simple by including an AirTite™ gasket in each housing to complete the final installation of the can opening. Should the gaskets be lost or discarded during the rough-in phase of installation these replacement kits are available.

5001 Metal Baffle Splay

- Straight Precision Sided Trim Ring
- Torsion Springs pull trim tight to ceiling
- Dual socket position for use with BR and PAR Lamps
- Lamps

H5ICAT	50W R20, 50W PAR20, 65W BR30, 75W PAR30
H5RICAT	30W R20, 35W PAR20, 60W BR30, 50W PAR30, 50W PAR30L

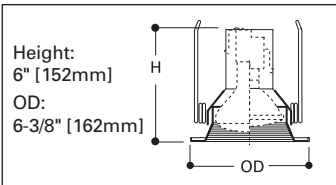

5001SN
Satin Nickel Trim with Satin Nickel Baffle

5001MB
White Trim with Black Baffle

5001P
White Trim with White Baffle



5001TBZ
Tuscan Bronze Trim with Tuscan Bronze Baffle

5001AC
Antique Copper Trim with Antique Copper Baffle

5010 Step Baffle

- Straight Precision Sided Trim Ring
- Torsion Springs pull trim tight to ceiling
- Dual Socket Position for BR and PAR Lamps
- Lamps:

H5ICAT	60W BR30, 50W PAR30
H5RICAT	60W BR30, 50W PAR30, 50W PAR30L

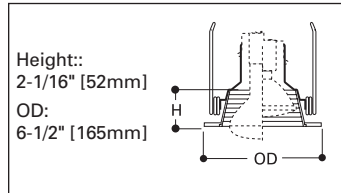

5010SL
Silver Trim with Black Baffle

5010W
White Trim with White Baffle

5010
White with Black Baffle

5014 Shallow Metal Baffle

- Straight Precision Sided Trim Ring
- Torsion springs pull trim tight to ceiling
- Lamps:

H25ICAT	50W PAR30, 65W BR30, 75W PAR30L
----------------	---------------------------------

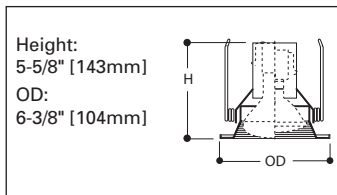

5014MB
White Trim with Black Baffle

5014P
White Trim with White Baffle

OT500P Oversize Trim Ring

- Fits the new H5 trim family "Precision style" trim rings
- Oversize trim ring corrects for uneven ceiling cutout
- Adds 3/8" onto the trim flange
- Satin White plastic Ring



OT500P
Oversize Trim Ring for Straight precision sided H5 family trim

H5ICAT H5RICAT H25ICAT

5016 Coilex® Baffle with Reflector and Torsion Springs

- Straight Precision Sided Trim Ring
- Torsion Springs pull trim tight to ceiling
- Dual Socket Position for BR and PAR Lamps
- Lamps:

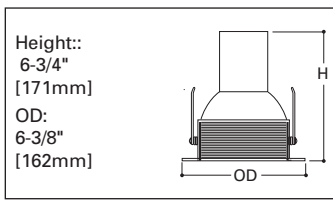

5016W
White Trim with White Baffle

5016P
White Trim with Black Baffle

H5ICAT	50W PAR30, 65W BR30, 75W PAR30L
H5RICAT	

5060 Adjustable Gimbal - 20° Tilt

- Straight Precision Sided Trim Ring
- For Directional Accent Lighting
- Torsion Springs pull trim tight to ceiling
- 20° Tilt - 360° Rotation
- Lamps:

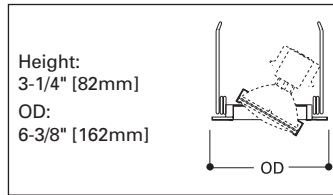

5060P
White Trim with White Gimbal

H5ICAT	50W PAR30
H5RICAT	
H25ICAT	50W PAR30, 50W R30

5070 Adjustable Eyeball - 30° Tilt

- Straight Precision Sided Trim Ring
- For Directional Accent Lighting
- Torsion Springs pull trim tight to ceiling
- 30° Tilt - 360° Rotation

H5ICAT	75W PAR30
H5RICAT	
H25ICAT	

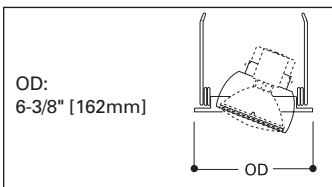

5070SL
Silver Trim with Silver Eyeball

5070PB
Polished Brass Trim with Polished Brass Eyeball

5070P
White Trim with White Eyeball



5070TBZ
Tuscan Bronze Trim with Tuscan Bronze Eyeball

5070AC
Antique Copper Trim with Antique Copper Eyeball

5070SN
Satin Nickel Trim with Satin Nickel Eyeball

OT500P Oversize Trim Ring

- Fits the new H5 trim family "Precision style" trim rings
- Oversize trim ring corrects for uneven ceiling cutout
- Adds 3/8" onto the trim flange
- Satin White plastic Ring



OT500P
Oversize Trim Ring for Straight precision sided H5 family trim

H5ICAT H5RICAT H25ICAT

5071 Adjustable Eyeball - 30° Tilt

- Straight Precision Sided Trim Ring
- For Directional Accent Lighting
- Torsion Springs pull trim tight to ceiling
- 30° Tilt - 360° Rotation
- Lamps:

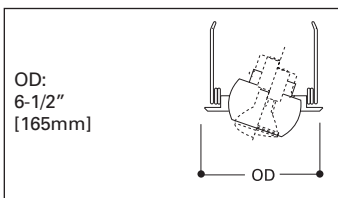

5071P
White Trim with White Eyeball

H5ICAT	50W R20, 50W PAR20
H5RICAT	
H25ICAT	

5000 Splay Trim

- Open metal Splay Trim
- Dual Socket position socket for BR and PAR lamps
- Lamps:

H5ICAT	65W BR30, 75W R30, 75W PAR30
H5RICAT	50W PAR30, 75W PAR30L, 60W BR30
H25ICAT	60W BR30, 50W PAR30, 50W PAR30L

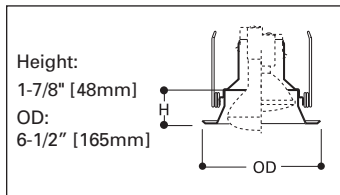

5000AC
Antique Copper Trim and Antique Copper Splay

5000SN
Satin Nickel Trim and Satin Nickel Splay

5000P
White Trim and White Splay

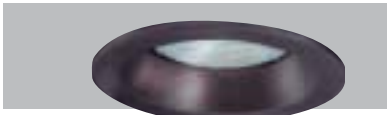

5000TBZ
Tuscan Bronze Trim and Tuscan Bronze Splay

OT500P Oversize Trim Ring

- Fits the new H5 trim family "Precision style" trim rings
- Oversize trim ring corrects for uneven ceiling cutout
- Adds 3/8" onto the trim flange
- Satin White plastic Ring



OT500P
Oversize Trim Ring for Straight precision sided H5 family trim

H5ICAT H5RICAT H25ICAT

5054

Shower Light

- Frosted glass dome shower light
- Wet location listed
- Non conductive, non corrosive polymer trim ring
- Lamps:

H5ICAT H5RICAT H25ICAT	40W A19, 50W PAR30
---------------------------------------	--------------------

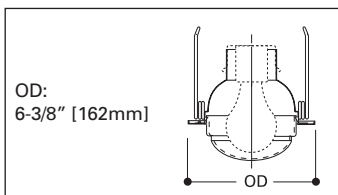

5054ACS
Antique Copper with Frosted Diffuser

5054SNS
Satin Nickel Trim with Frosted Diffuser

5054PS
White Trim with Frosted Diffuser

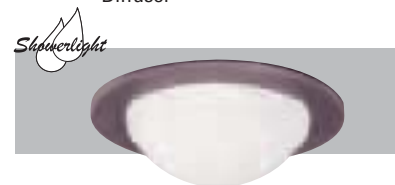

5054TBZS
Tuscan Bronze with Frosted Diffuser

5051

Frosted Lens Shower Light

- Straight Sided Trim Ring
- Frosted albalite lens
- Wet location listed for use in showers
- Lamps:

H5ICAT H5RICAT	35W PAR30L
---------------------------	------------

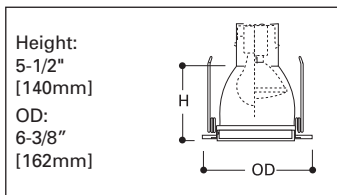

5051PS
White Trim with Frosted Lens

OT500P

Oversize Trim Ring

- Fits the new H5 trim family "Precision style" trim rings
- Oversize trim ring corrects for uneven ceiling cutout
- Adds 3/8" onto the trim flange
- Satin White plastic Ring



OT500P
Oversize Trim Ring for Straight precision sided H5 family trim