

**JUNO**®

Project: \_\_\_\_\_

Fixture Type: \_\_\_\_\_

Location: \_\_\_\_\_

Contact/Phone: \_\_\_\_\_

# 6" VERTICAL COMPACT FLUORESCENT HOUSING

26/32/42W  
COMPACT FLUORESCENT LAMP  
**PL642EU**

## PRODUCT DESCRIPTION

PL housing designed for use in non-insulated areas • If installed where insulation is present, the insulation must be pulled back 3" from all sides of the PL housing • Easy access ballast.

## PRODUCT SPECIFICATIONS

**Lamp** One 26/32/42W triple tube (4-pin) CFL lamp.

**Socket** Supplied with spring to accommodate certain trim installations, or can be attached to top of housing for certain trims.

**Ballast** 120V thru 277V HPF Rapid Start Electronic with end-of-life lamp protection • UL listed/CSA certified • Mounted between j-box and housing for ease of maintenance.

**Trims** Trim selection shown on reverse.

**Labels** UL listed for through-branch wiring and damp locations • Union made AFL-CIO • UL and C-UL Listed • Trims 220, 239, 241, 242, 243, 271, 6101 and 9900 are wet location approved for covered ceiling applications.

**Testing** All reports are based on published industry procedures; field performance may differ from laboratory performance.

Product specifications subject to change without notice.

## INSTALLATION

**Real Nail 3 Bar Hangers** Telescoping, patent-pending Real Nail 3 system permits quick placement of housing anywhere within 24" O.C. joists or suspended ceilings • Integral T-bar notch and clip secures housing in suspended ceiling grid – no accessory clips required • 24" expansion stop allows quick placement of fixture in standard grid spacing • Bars scored in two locations for fast, clean breaking, allowing housing installation in tight applications • Bars captive to mounting frame • Edge-mounted for extra strength • Captive bugle-headed ring shank nail for quick one-step installation and easy removal with claw hammer for fixture relocation • Quick-Loc slot and oversized locking set screw lock fixture in position • Bar hanger foot contoured to align to bottom of construction joist • Alternate mounting holes included.

**Junction Box** Pre-wired junction box provided with (5) ½" and (1) ¾" knockouts, (4) Romex connectors and ground wire, UL and C-UL Listed for through-branch wiring, maximum (8) No. 12 AWG 90° C branch circuit conductors (4 in, 4 out) • Junction box provided with removable access plate • Knockouts equipped with pryout slots.

**Mounting Frame** 22-gauge die-formed galvanized steel mounting frame • Rough-in section (junction box, mounting frame, housing ballast and bar hangers) fully assembled for ease of installation.

**Housing** 22-gauge white painted steel • Housing is vertically adjustable to accommodate up to a 2" ceiling thickness.

## PRODUCT CODES

Catalog Number	Input Voltage	Lamp Rating (max.)
PL642EU	120V - 277V	26/32/42W Triple Tube (4-pin) CFL

REV-10/07

## DIMENSIONS

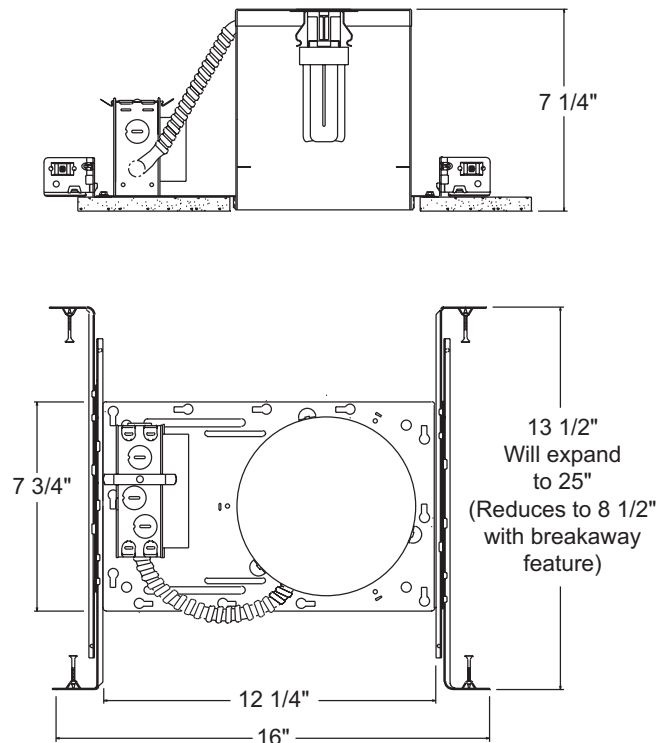















6 7/8" CEILING CUTOUT

# 6" VERTICAL COMPACT FLUORESCENT HOUSING

26/32/42W  
COMPACT FLUORESCENT LAMP

**PL642EU**

## TRIMS/LAMPS

	Cat. No.	Description	Lamp Rating
	<b>220-WH</b> ◆ <b>220-PW</b> ◆	Albalite lens with Reflector Shower/Closet Light	26W Triple Tube (4-pin) CFL
	<b>241-WH</b> ◆ <b>241-PW</b> ◆	Drop Opal with Reflector Shower/Closet Light	26W Triple Tube (4-pin) CFL
	<b>242-WH</b> ◆ <b>242-SC</b> ◆ <b>242-ABZ</b> ◆	Shower Trim, Frosted Lens with Clear Center Shower Trim, Frosted Lens with Clear Center Shower Trim, Frosted Lens with Clear Center	42W Triple Tube (4-pin) CFL
	<b>243-WH</b> ◆	Decorative Swirl Etched Opal Glass	32W Triple Tube (4-pin) CFL
	<b>239-WH</b> ◆	Frosted Lens with Reflector	32W Triple Tube (4-pin) CFL
	<b>271-PW</b> ◆	Drop Opal with Reflector	32W Triple Tube (4-pin) CFL
	<b>28W-WH</b> <b>28B-WH</b>	Conical White Baffle Conical Black Baffle	42W Triple Tube (4-pin) CFL
	<b>29C-WH</b> <b>29W-WH</b>	Deep Cone - Clear Deep Cone - White	42W Triple Tube (4-pin) CFL
	<b>232C-WH</b> <b>232G-WH</b> <b>232W-WH</b> <b>232HZ-WH</b> <b>232WHZ-WH</b>	Multiplier - Clear Alzak® Multiplier - Gold Alzak® Multiplier - Gloss White Multiplier - Haze Multiplier - Wheat Haze	42W Triple Tube (4-pin) CFL*
	<b>2320C-WH</b> <b>2320HZ-WH</b> <b>2320WHZ-ABZ</b> <b>2320WHZ-WH</b>	Multiplier in Clear Low Iridescent Alzak® Multiplier in Haze Multiplier in Wheat Haze Multiplier in Wheat Haze	42W Triple Tube (4-pin) CFL
	<b>233C-WH</b>	Multiplier in Clear Alzak® with Black Baffle, White Trim	42W Triple Tube (4-pin) CFL
	<b>261W-WH</b> <b>261B-WH</b>	Scoop Wall Wash with White Baffle Scoop Wall Wash with Black Baffle	26W Triple Tube (4-pin) CFL
	<b>6101-ABZ</b> ◆ <b>6101-SC</b> ◆ <b>6101-WH</b> ◆	Beveled Frame - Frosted Dome Lens with Reflector Beveled Frame - Frosted Dome Lens with Reflector Beveled Frame - Frosted Dome Lens with Reflector	42W Triple Tube (4-pin) CFL
	<b>9900-WH</b> ◆	Fluted Drop Opal Lens	32W Triple Tube (4-pin) CFL*

Trim Size: Catalog Numbers 242, 243, 239, 271, 28, 29, 232, 2320, 233, 261, 9900 - 7<sup>5</sup>/<sub>8</sub>" O.D. Catalog Numbers 220, 241 - 8" O.D. Catalog Number 6101 - 7<sup>3</sup>/<sub>4</sub>" O.D.  
Trim Finish: ABZ - Classic Aged Bronze, PW - Plastic White (Polycarbonate material shower trim), SC - Satin Chrome, WH - White.

Alzak is a registered trademark of Alcoa Corp.  
Note: In Canada when insulation is present, Type IC fixtures must be used.

\*Use only Osram Sylvania or G.E. lamps.

◆ UL Listed for use in wet location.



1300 S. Wolf Road • P.O. Box 5065 • Des Plaines, IL 60017-5065 • Phone (847) 827-9880 • Fax (847) 827-2925  
220 Chrysler Drive • Brampton, Ontario • Canada L6S 6B6 • Phone (905) 792-7335 • Fax (905) 792-0064  
Visit us at [www.junolightinggroup.com](http://www.junolightinggroup.com)

Printed in U.S.A. ©2007 Juno Lighting, Inc.