



# 4" LOW VOLTAGE UNIVERSAL TC HOUSING

75W MR16

TC47

Project: \_\_\_\_\_

Fixture Type: \_\_\_\_\_

Location: \_\_\_\_\_

Contact/Phone: \_\_\_\_\_

## PRODUCT DESCRIPTION

TC Housing design for use in non-insulated areas • If installed where insulation is present, the insulation must be pulled back 3" from all sides of the TC housing.

## PRODUCT SPECIFICATIONS

**Lamp** One 12V, 75W MR16 lamp (certain trims limited to 50W - see trim selection).

**Socket** Ceramic bi-pin socket with aluminum heat shield.

**Trims** Trim selection shown on reverse.

**Transformer** 120V to 12V 75VA thermally protected magnetic transformer mounted to junction box.

**Dimming** May be dimmed using dimmers specifically designed for low voltage magnetic transformers; consult factory or dimmer manufacturer for additional information.

**Labels** U.L. listed for through-branch wiring, damp locations and IP • Product thermally protected against improper use of lamps or insulation • Union made AFL-CIO • UL Listed/CSA certified • Trim No. 441 is wet location approved for covered ceiling applications.

**Testing** All reports are based on published industry procedures; field performance may differ from laboratory performance.

Product specifications subject to change without notice.

## INSTALLATION

**Real Nail 3 Bar Hangers** Telescoping, patent-pending Real Nail 3 system permits quick placement of housing anywhere within 24" O.C. joists or suspended ceilings • Integral T-bar notch and clip secures housing in suspended ceiling grid – no accessory clips required • 24" expansion stop allows quick placement of fixture in standard grid spacing • Bars scored in two locations for fast, clean breaking, allowing housing installation in tight applications • Bars captive to mounting frame • Edge-mounted for extra strength • Captive bugle-headed ring shank nail for quick one-step installation and easy removal with claw hammer for fixture relocation • Quick-Loc slot and oversized locking set screw lock fixture in position • Bar hanger foot contoured to align to bottom of construction joist • Alternate mounting holes included.

**Junction Box** Pre-wired junction box provided with (5) 1/2" and (1) 3/4" knockouts, (4) Romex connectors and ground wire, U.L. listed/CSA certified for through branch wiring, maximum 8 No. 12 AWG 90° C branch circuit conductors (4 in, 4 out) • Junction box provided with removable access plates • Knockouts equipped with pryout slots.

**Mounting Frame** 22-gauge die-formed galvanized steel mounting frame • Rough-in section (junction box, mounting frame, housing and bar hangers) fully assembled for ease of installation.

**Housing** TC housing, .040" thick aluminum • Housing is vertically adjustable to accommodate up to a 1" ceiling thickness.

## DIMENSIONS

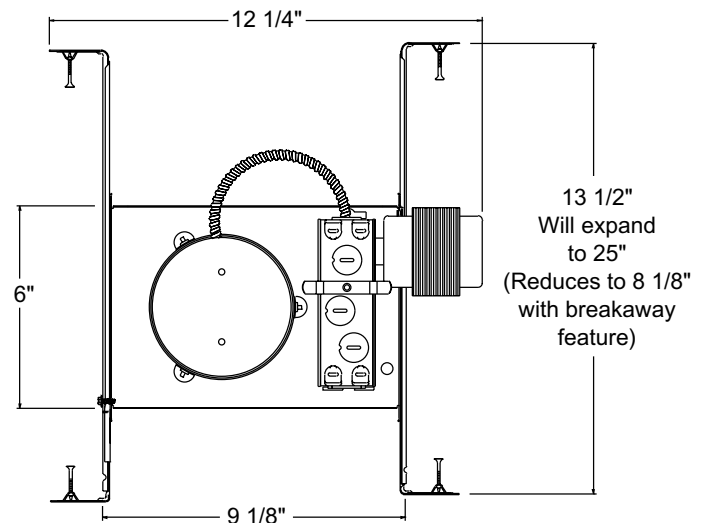
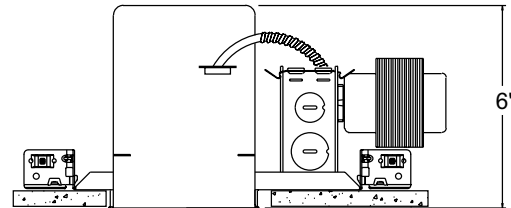

4 1/2" CEILING CUTOUT

## ACCESSORIES

Catalog No.	Description
4TSA	Torsion Spring Adapter (for original style housing)

To order, specify catalog number.







## PRODUCT CODES

Catalog Number	Input Voltage	Lamp Rating (max.)
TC47	120V	12V 75W MR16

# 4" LOW VOLTAGE UNIVERSAL TC HOUSING

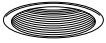
75W MR16  
TC47

## TRIMS (MAXIMUM 12V 75W MR16)

Cat. No.	Description	Cat. No.	Description
 <b>443B-WH</b>	Pinhole with Black Baffle Downlight	 <b>447C-WH</b> <b>447G-WH</b> <b>447B-WH</b> <b>447PT-SC</b> <b>447HZ-WH</b> <b>447WHZ-WH</b> <b>447WHZ-ABZ</b>	Downlight or Adjustable - Clear Alzak® Downlight or Adjustable - Gold Alzak® Downlight or Adjustable - Black Alzak® Downlight or Adjustable - Pewter Alzak® Downlight or Adjustable - Haze Downlight or Adjustable - Wheat Haze Downlight or Adjustable - Wheat Haze 35° Vertical Adjustment
 <b>444B-WH</b> <b>444B-SC</b> <b>444B-ABZ</b> <b>444W-WH</b>	Downlight or Adjustable with Black Baffle Downlight or Adjustable with Black Baffle Downlight or Adjustable with Black Baffle Downlight or Adjustable with White Baffle 35° Vertical Adjustment	 <b>448-WH</b> <b>448-PB</b> <b>448-SC</b>	Eyeball with Black Baffle Eyeball with Black Baffle Eyeball with Black Baffle 35° Vertical Adjustment
 <b>445-WH</b>	Slot Aperture Downlight or Adjustable 50° Vertical Adjustable	 <b>XR16101WH</b> <b>XR16101BL</b> <b>XR16101GP</b> <b>XR16101SL</b>	AVIO Square Gimbal Ring - White AVIO Square Gimbal Ring - Black AVIO Square Gimbal Ring - Graphite AVIO Square Gimbal Ring - Silver
 <b>446-WH</b>	Scoop Adjustable 50° Vertical Adjustable		

## TRIMS (MAXIMUM 12V 50W MR16)

Cat. No.	Description	Cat. No.	Description
 <b>440-WH</b> <b>440-BL</b> <b>440-SC</b> <b>440-ABZ</b>	Flush Gimbal Ring - White Flush Gimbal Ring - Black Flush Gimbal Ring - Satin Chrome Flush Gimbal Ring - Classic Aged Bronze 40° Vertical Adjustment	 <b>449-WH</b> <b>449-BL</b> <b>449-SC</b> <b>449-ABZ</b>	75° Aiming Adjustable 75° Vertical Adjustment
 ◆ <b>441W-WH</b> ◆ <b>441W-SC</b> ◆ <b>441W-ABZ</b>	Adjustable Shower Trim, frosted lens with clear center 35° Vertical Adjustment		
 <b>442C-WH</b> <b>442G-WH</b> <b>442B-WH</b> <b>442HZ-WH</b> <b>442WHZ-WH</b>	Deep Cone Downlight - Clear Alzak® Deep Cone Downlight - Gold Alzak® Deep Cone Downlight - Black Alzak® Deep Cone Downlight - Haze Deep Cone Downlight - Wheat Haze		

Note: Lamps may be dimmed. Use dimmers specifically designed for low voltage magnetic transformers; consult factory or dimmer manufacturer for additional information.

Trim Size: 5" O.D.

Trim Finish: ABZ - Classic Aged Bronze, BL - Black, GP - Graphite, PB - Polished Brass,  
PW - Plastic White (Polycarbonate material shower trim), SC - Satin Chrome, SL - Silver, WH - White.  
Alzak is a registered trademark of Alcoa Corp.

◆ UL Listed for use in wet location.



1300 S. Wolf Road • P.O. Box 5065 • Des Plaines, IL 60017-5065 • Phone (847) 827-9880 • Fax (847) 827-2925  
220 Chrysler Drive • Brampton, Ontario • Canada L6S 6B6 • Phone (905) 792-7335 • Fax (905) 792-0064  
Visit us at [www.junolightinggroup.com](http://www.junolightinggroup.com)

Printed in U.S.A. ©2005 Juno Lighting, Inc.