

SINGLE HANDLE KITCHEN FAUCET

Description

- Single lever handle with 9" D-tube spout
- Matching spray

Flow & Valving

- See Chart

Standards

- ASME A112.18.1
- CSA B125
- NSF 61-9
- Listed IAPMO/UPC
- Energy policy act of 1992
- ADA Accessibility Guidelines for Buildings and Facilities - 4.27.4 Controls and Mechanisms 

Warranty

Danze faucets are covered by a manufacturer's limited "lifetime" warranty for manufacturing defects.



D403412 (with spray)
MELROSE™



Available Colors & Finish

- Chrome
- Stainless Steel (SS)

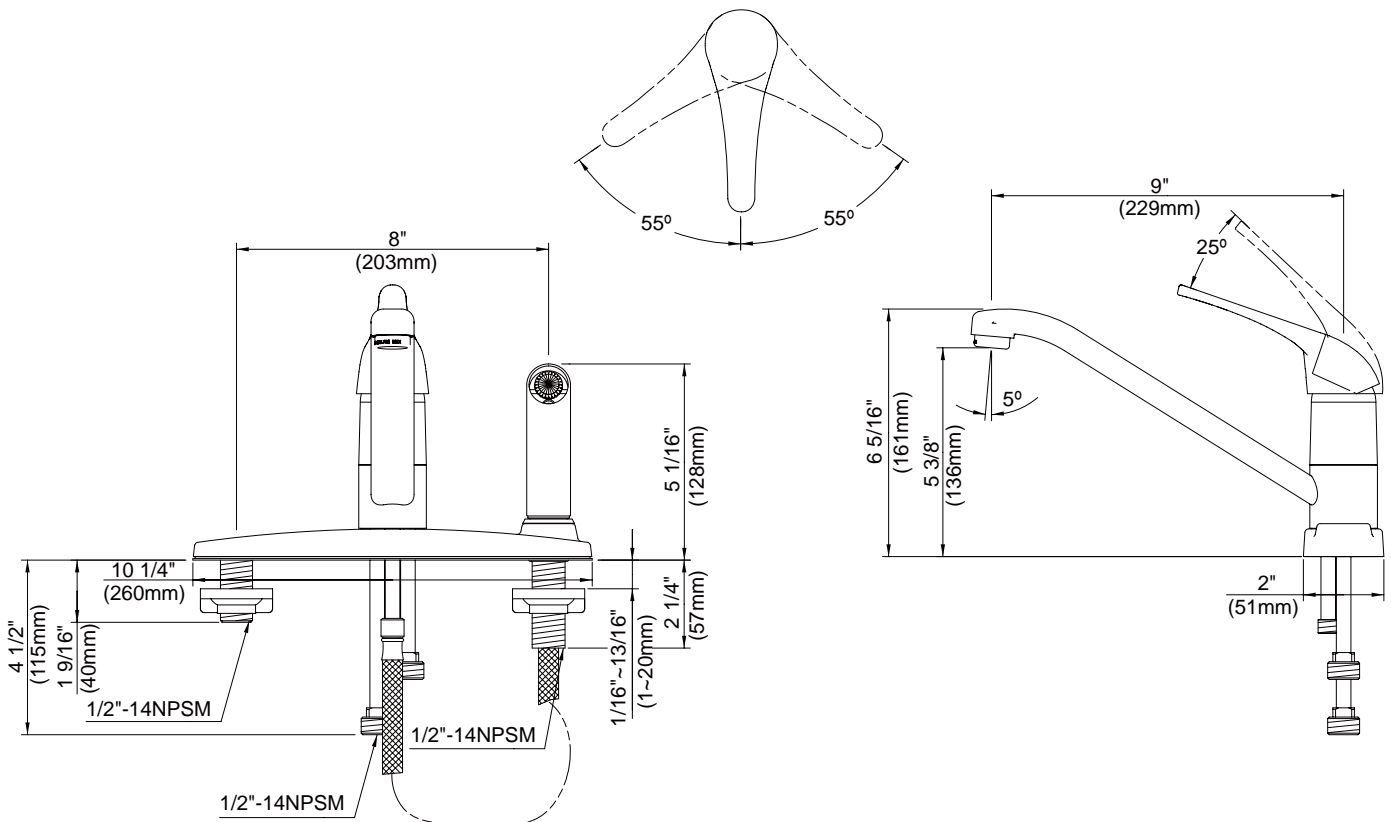
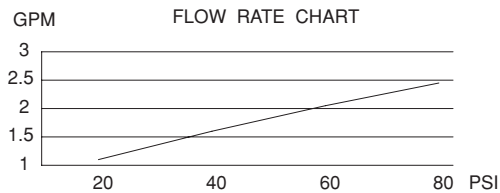

Specific Features: _____ Submitted Model No.: _____

SD403412/01-07.01