

Toilet Glass Shelf Installation

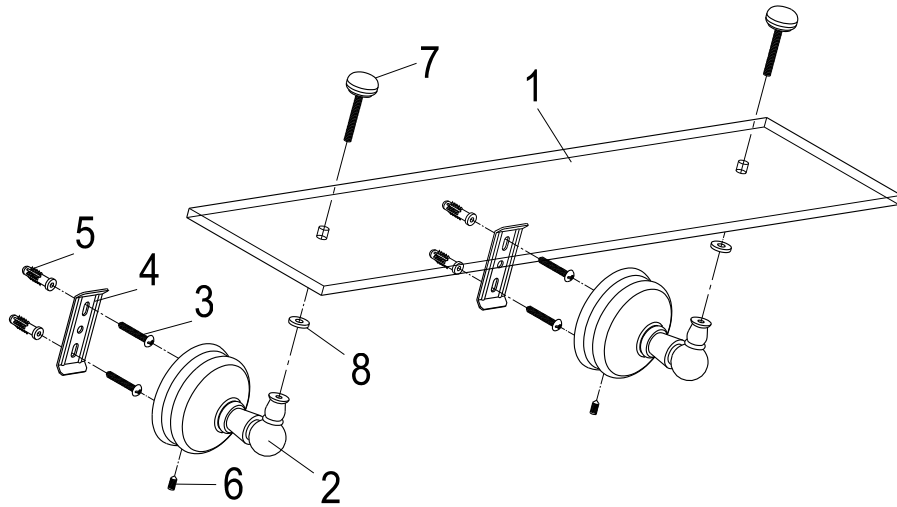

PART NAME	QUANTITY	PART NAME	QUANTITY
① Glass Plate	1	⑤ Anchor	4
② Base	2	⑥ Slotted Set Screw	2
③ Mounting Screw	4	⑦ Screw	2
④ Mounting Plate	2	⑧ Cushion	2

www.kingstonbrass.com
TOLL-FREE CUSTOMER SERVICE: 877-2-KBRASS
TECHNICAL SUPPORT E-mail: service@kingstonbrass.com
6240 Prescott Court, Chino, CA91710

TOOLS REQUIRED

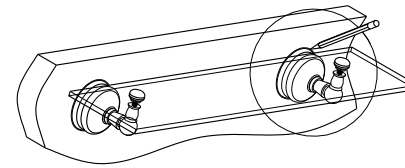
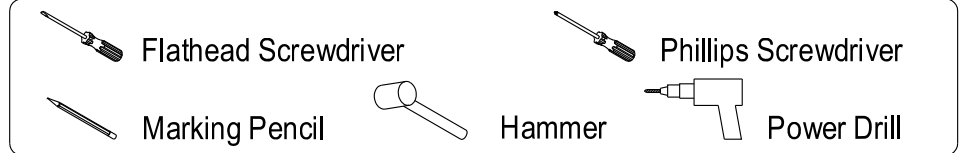

Fig. 1

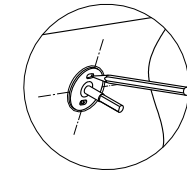

Fig. 2

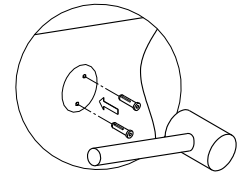

Fig. 3

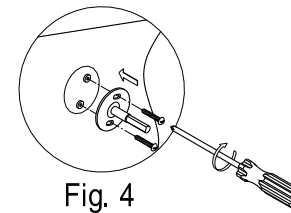

Fig. 4

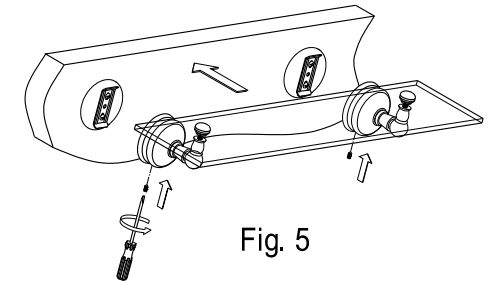

Fig. 5

Installation Steps:

- Step 1. Locate position on the wall and mark outline of cover plate on the wall. (Fig.1)
- Step 2. Unscrew Slotted Set Screw at base and remove mounting plate.
- Step 3. Locate mounting plate in the center of circle. Mark location of the mounting screw (Fig.2) and drill holes at the marked location.
- Step 4. Insert anchors into the holes until flush with wall. (Fig.3)
- Step 5. Screw the mounting plate (with the lips facing out) to wall with mounting screw. (Fig.4)
- Step 6. Repeat steps from 3 to 6 to another side.
- Step 7. Place the unit, with the small hole of cover plate underneath, over the mounting plate by tightening slotted set screw with flathead screwdriver until the base is tightly fixed. (Fig.5)

Cleaning

Clean with a damp cloth only.

Avoid using metal or abrasive polishes.

© Copy Rights : 2009 Kingston Brass