



Buy it for looks. Buy it for life.®

Specifications

SINK DESCRIPTION

- Manufactured of 18 gauge, type 301 nickel-bearing stainless steel
- The two bowls are a minimum of 13" x 16-1/2" x 10"
- Has two 3-1/2" diameter recessed drain openings
- Soundshield undercoating maximizes sound deadening and inhibits condensation
- The exposed surfaces are polished to a lustrous satin tone finish
- Silicone sealant not provided. Includes mounting bracket. Other standard mounting hardware not included

INSTALLATION

- Template enclosed with sink
- Template ordering number 22524

STANDARDS

- Third party certified by IAPMO to meet ASME A112.19.3 and all applicable specifications referenced therein.

WARRANTY

- Warranted for fifteen years against material or manufacturing defects

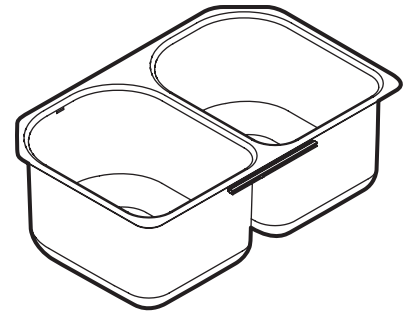

**Lancelot® Undermount
Double Bowl Kitchen Sink
Model: 22392
(UMTLDE-27"x16"x10")**

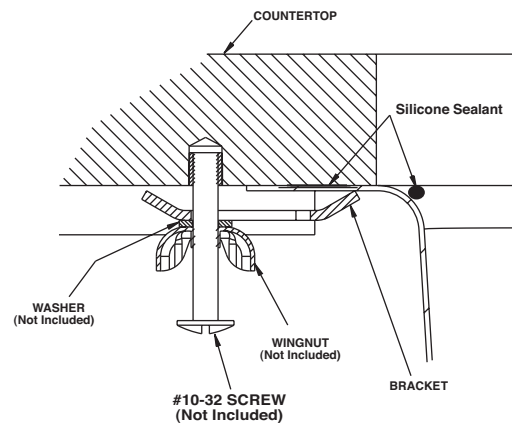

Installation Detail

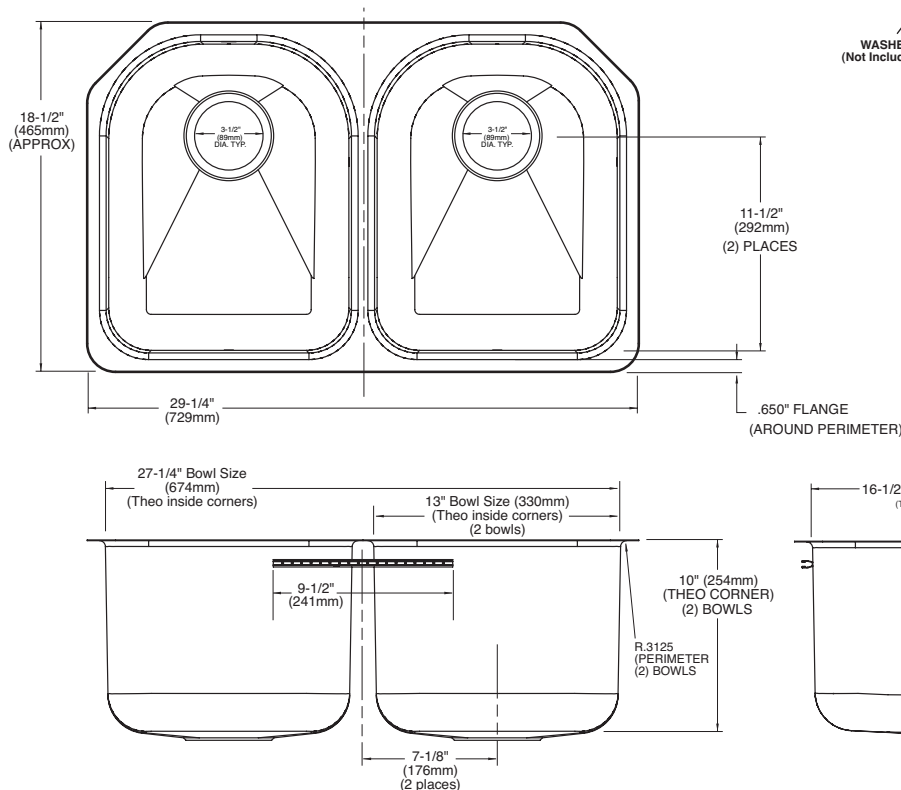

CRITICAL DIMENSIONS

(DO NOT SCALE)

FOR MORE INFORMATION CALL: 1-800-BUY-MOEN

www.moen.com