

RAB LIGHTING

WPTS50



JOB NAME: _____
 DATE: _____
 TYPE: _____

DESCRIPTION

HPS "Tall" Wallpack. Vandal resistant polycarbonate housing. Heavy die-cast aluminum back plate with 1/2" bottom and back conduit knockout. Factory installed photocontrol optional. Lamp supplied.

SPECIFICATIONS

Back Plate:

Heavy die cast aluminum. 1/2" bottom conduit knockout. Knockouts for mounting to 3" or 4" junction boxes

Ballast Housing:

Stamped steel painted white

Reflector:

Die formed aluminum for wide light distribution

UL Listing:

Suitable for wet locations

Housing:

Vandal resistant polycarbonate housing

Patents:

RAB sensor and fixture designs are protected under U.S. and International Intellectual Property laws.

Refractor:

Prismatic polycarbonate refractor for wide light distribution

Socket:

Porcelain 4kv Pulse Rated

Color:

Bronze

Weight:

5.6

DIMENSIONS

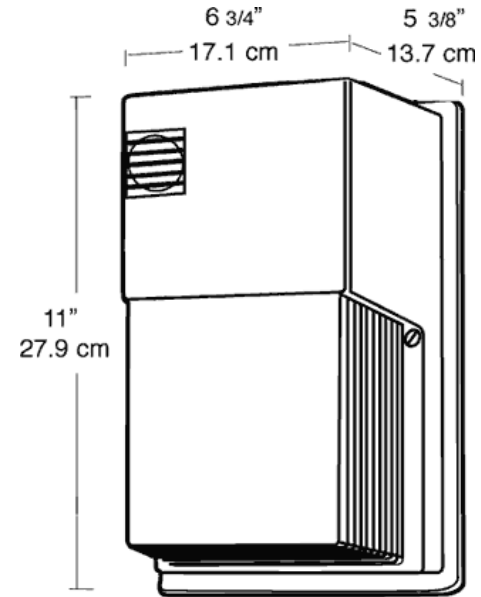

PHOTOMETRIC

70w HPS @ 10' Mounting Height

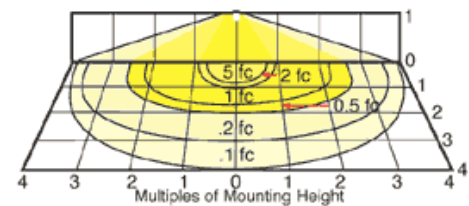

Mounting Height	Multiplier	HPS Watts	CFL Multiplier	Watts	Multiplier
8'	1.6	100	1.5	22	.2
10'	1.0	70	1.0	42	.5
12'	.7	50	.6		
16'	.4	35	.4		
20'	.25				
MH		Watts	Multiplier		
		100	1.4		

ORDERING INFORMATION

High Pressure Sodium
 Lamp supplied with fixture

Total Watts	Lamp Type	Lamp Base	Ballast
50	ED17	Medium	R-NPF 120V

Starting Amps/ Operating Amps			
120V	208V	240V	277V
1.8/1.2			

Input Watts	LAMP ANSI	Initial Lumens	Lamp Hours
62	S68	4000	24000

Factory Installed Options
 Add suffix to Catalog Number

Tamperproof screws (/TP)
 Swivel Photocontrol (/PCS)
 Single fusing for 120 and 277 volt (/F)

Double fusing for 208 and 240 volt (/FF)
 Button Photocontrol (/PC)

Note: Specifications may change without notice