



WP1CH70/PC



JOB NAME: _____
 DATE: _____
 TYPE: _____

DESCRIPTION

Cutoff Wallpack. Lens is flat with tempered glass. Lamp supplied.

SPECIFICATIONS

Finish:

Chip and fade resistant polyester powder coating.

Housing:

Die cast aluminum, 1/2" NPS tapped top, both sides and back for conduit or photocontrol. Hinged refractor. Continuous one piece silicone rubber gasket.

Reflector:

Semi-Specular anodized aluminum, removable for installation. Symmetrical light pattern maximizes distance between fixtures.

UL Listing:

Suitable for wet locations. HID fixtures can be wired with 90° C supply wiring if supply wires are routed 3" away from the ballast.

Conduit Openings:

Top, side, and back

EISA 2007 Compliant

This product complies with the new law for metal halide ballast efficiency. This law goes into effect January 1st, 2008

Patents:

Pat. D440,683

Photocontrol:

Button Photocontrol installed and wired for 120V

Template:

Drilling template for easy wall box mounting

Color:

Bronze

Weight:

9.97

DIMENSIONS

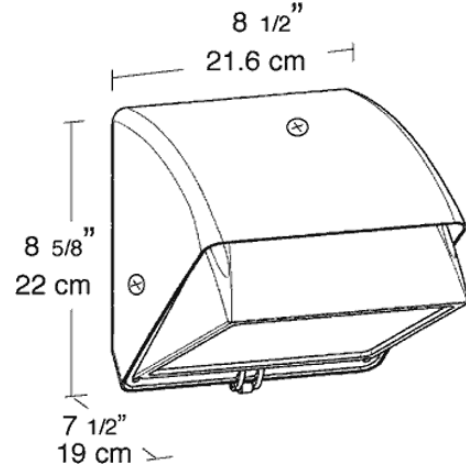

PHOTOMETRIC

70w MH @10' Mounting Height

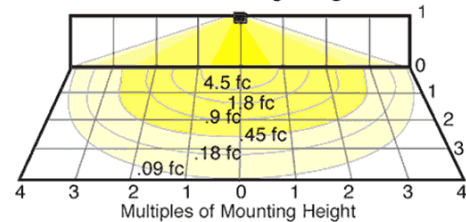

Mounting Height	Multiplier	Multiplier		
		Watts	HPS	MH CFL
8'	1.6	100	1.7	1.6
10'	1.0	70	1.1	1.0
12'	.7	50	.7	.6
16'	.4	42		.6
20'	.25	35	.4	

ORDERING INFORMATION

Metal Halide Lamp supplied with fixture	Total Watts	Lamp Type	Lamp Base	Ballast	Starting Amps/ Operating Amps				Input Watts	LAMP ANSI	Initial Lumens	Lamp Hours
					120V	208V	240V	277V				
	70	ED17	Medium	HX-NPF 120V	2.5/2.1				94	M98	5600	15000

Factory Installed Options
 Add suffix to Catalog Number

Tamperproof screws (/TP)
 Swivel Photocontrol (/PCS)
 Single fusing for 120 and 277 volt (/F)

Button Photocontrol wired for 208 - 277 volt (/PC2)
 Button Photocontrol (/PC)

Note: Specifications may change without notice