

# RAB LIGHTING

## EZSH50



JOB NAME: \_\_\_\_\_  
 DATE: \_\_\_\_\_  
 TYPE: \_\_\_\_\_

### DESCRIPTION

Versatile HPS Floodlight with hinged lens frame and hydroformed reflector. Field adjustable vertical and horizontal lamp positions. Lamp supplied.

### SPECIFICATIONS

#### Finish:

Chip and fade resistant polyester powder coat finish

#### Ground Mounting:

Use the new MPM19 PVC Mighty Post with aluminum cap for sturdy installation

#### Housing:

Precision die cast aluminum. 1/2" NPS threaded arm with locking swivel

#### Lens Frame:

Precision die cast aluminum. Hinged for easy access

#### Lens Gasket:

High temperature tubular silicone set in die cast retaining groove remains in place during relamping.

#### Reflector:

Hydroformed aluminum. Field adjustable vertical or horizontal

#### Socket:

Porcelain 4kv Pulse Rated socket with nickel plated screw shell

#### UL Listing:

Suitable for wet locations. Suitable for mounting within 4' of the ground

#### EPA:

0.6

#### Patents:

RAB sensor and fixture designs are protected under U.S. and International Intellectual Property laws

#### Color:

Bronze

#### Weight:

8.45

### DIMENSIONS

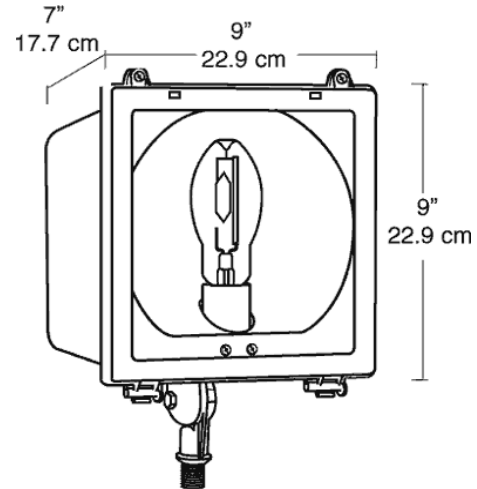

### PHOTOMETRIC

150w HPS @ 10' Mounting Height  
 Aimed 30° below horizontal

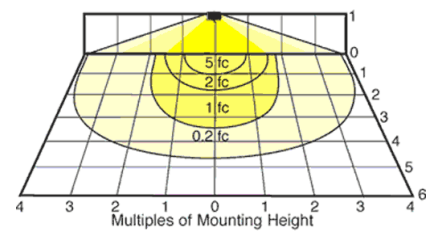

Mounting Height	Multiplier	Watts	Multiplier HPS	MH
8'	1.6	175	.9	
10'	1.0	150PS	1.0	
12'	.7	150	1.0	.8
16'	.4	100	.6	.6
20'	.3	70	.4	.4
		50	.3	.2
		35	.2	

### ORDERING INFORMATION

**High Pressure Sodium**  
 Lamp supplied with fixture

Total Watts	Lamp Type	Lamp Base	Ballast	Starting Amps/ Operating Amps				Input Watts	LAMP ANSI	Initial Lumens	Lamp Hours
				120V	208V	240V	277V				
50	ED17	Medium	R-HPF 120V	1.0/.6				62	S68	4000	24000

**Factory Installed Options**  
 Add suffix to Catalog Number

Swivel Photocontrol wired for 120V (/PCS)      Dual Tap works with 120 / 277 volts (/DT)  
 Quad Tap works with 120, 208, 240 and 277 volts (/QT)      Photocontrol wired for 120V (/PC)

Note: Specifications may change without notice

**RAB Lighting, Inc.** • 170 Ludlow Ave • Northvale, NJ 07647 • Tel: 888 RAB-1000 • Fax: 888 RAB-1232 • www.rabweb.com  
 © 2008