

R56 INSTALLATION INSTRUCTIONS

Read Instructions Completely
Before Installation

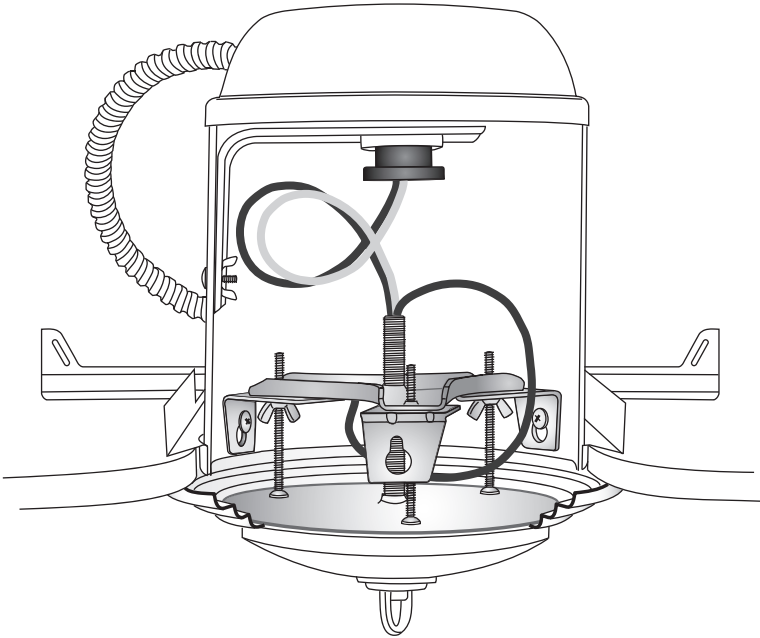

®
CONVERTER
CAN
THE

Recessed
Can Light
Conversion Kit

www.thecanconverter.com

WARNING: Risk of fire or electric shock. Disconnect power to existing luminaire at breaker box. Luminaires wiring, ballasts, or other electrical parts may be damaged when drilling for installation of the reflector kit hardware. Check for enclosed wiring and components. Do not alter, relocate, or remove wiring, lampholders, ballasts, or any other electrical components. Install this kit only in luminaires that has the construction features and dimensions shown in the photographs and/or drawings. To prevent wired damage, do not expose wiring to edge of sheet metal or other sharp objects. The Can Converter is not intended for installation on listed recessed incandescent luminaires installed on incline ceiling. Mount only on listed new construction cans with bar hangers. **DO NOT** install on t-bar suspended ceilings. 50lb. load rating for luminaires. Not intended for luminaires greater than 50lbs. 35lb. load rating for ceiling fans. Not intended for ceiling fans greater than 35lbs. Reflector kit requires knowledge of lighting luminaires electrical system. If not qualified, do not attempt installation. Contact a qualified electrician.

IMPORTANT: Verify proper can installation, bar hangers must be resting on ceiling (see picture below).

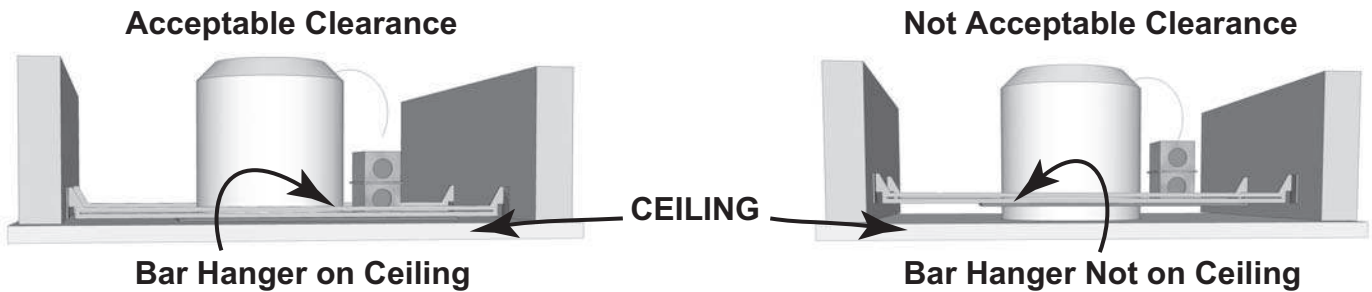

CONVERT ALL OF THESE RECESSED CAN LIGHT PRODUCTS	
Elco	EL71C, EL71CAT, EL51C, EL7171C00, EL71CCWA, EL51CAT
Halo	H17T, H7TNB, H71CT, H71CATNB, H51CAT, H71CAT, H71CT, H71CTNB
Elite	B61C, B51C-AT, B61CAT
Juno	IC2, IC21, IC22, IC20, TC2, TC20
Lithonia	L7, L7X, LC6, LU6, LUP, L5, LICJ
Lightolier	1104IC, 1004IC
Luminaire	LU1CT-00
Progress	P87AT

TOOLS NEEDED:
 Power Drill, Slotted Screw Driver, Phillips Screw Driver, Goggles

EYE PROTECTION

PARTS INCLUDED:

- POWER OUTLET ADAPTER (B)
- POWER LEADS (K)
- MOUNTING BRACKET (C)
- OFFSET SLIDING BRACKET (D)
- PHILLIPS SCREW X3 (F)
- WING NUT X3 (E)
- NUT (I)
- THREADED PIPE (G)
- MOUNTING PLATE (J)
- NUT (I)
- FLAT MEDALLION (H)
- BEVELED MEDALLION (H)
- SELF TAPPING SHEET METAL SCREWS X3
- # 10 NUTS X3
- REDUCER BUSHING

HANGING LIGHT FIXTURE: Using Beveled or Flat Medallion:

STEP 1. Verify contents of kit.

STEP 2. Install on new construction cans with bar hangers only. Not intended for remodel cans. Verified adaptability of can manufacture and model number using table on front side of instructions.

STEP 3. Assemble light fixture for final assembly and set aside.

STEP 4. Pre assemble mounting bracket (C) using phillips screws (F) and wing nuts (E) to hold offset sliding brackets (D) in place.

STEP 5. Remove light bulb and can trim.

STEP 6. Insert power outlet adapter (B) into light socket.

STEP 7. Loosen wing nut in can and raise light socket as high as possible (SEE FIGURE 1). Some can assemblies will not have this configuration, just set light socket aside.

STEP 8. Remove the (3) sheet metal screws in the can (SEE FIGURE 1) and replace with extended self tapping sheet metal screws (A) (install 1/2 way in). Some cans will not have these screws, so you will need to install the self tapping screws (A) by raising the mounting bracket assembling into the can and then slide the offset sliding brackets (D) to fit can (make sure the offset sliding brackets (D) are just above the ceiling (SEE FIGURE 2). Then mark locations for the self tapping screws. Remove mounting bracket (C) and install self tapping screws 1/2 way in. HINT: install one sheet metal screw first then mount offset sliding bracket (D) onto that screw. Now mark for the other two screws.

STEP 9. Install mounting bracket assembly into can and slide (at an angle) offset sliding brackets (D) onto sheet metal screws (A). Tighten sheet metal screws (A) to secure offset sliding brackets (D) in place.

STEP 10. Adjust phillips screws (F) on mounting bracket (C) until flush with ceiling (SEE FIGURE 3). Tighten wing nuts (E) to secure in place.

STEP 11. Install threaded pipe (G) into center hole on mounting bracket (C). Refer to installation instructions provided with light fixture on setting threaded pipe depth. IMPORTANT medallion (H) must be included in setting the threaded pipe depth (SEE FIGURE 4). When depth has been set remove medallion and light canopy then secure threaded pipe (G) with nut (I). Install mounting plate (J) onto threaded pipe (G) leaving space to make final electrical connections. Install nut (I) on threaded pipe (G) then attach light hook supplied with light fixture (SEE FIGURE 5).

STEP 12. Determine light fixture height and remove excess chain. Slide light hook nut onto light chain then light canopy followed by the medallion (H). Hang light on light hook. Insert light fixture power leads along with ground wire up through threaded pipe (G) (cut off excess wire). Make final electrical connections and verify all supply and grounding wires are secure and tight. Push wires up in can housing.

STEP 13. Spin mounting plate (J) up against phillips screws (F). Spin nut (I) up against mounting plate (J). Raise medallion (H) to ceiling, followed by the light canopy and secure in place with the light hook nut (SEE FIGURE 4).

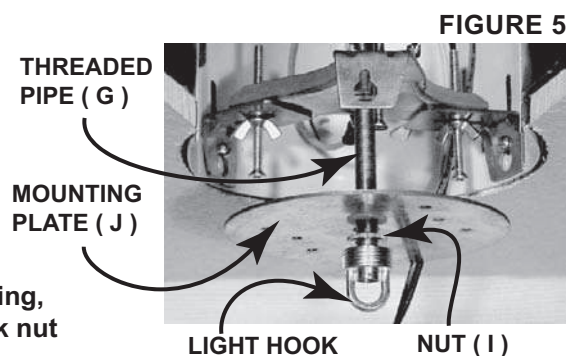
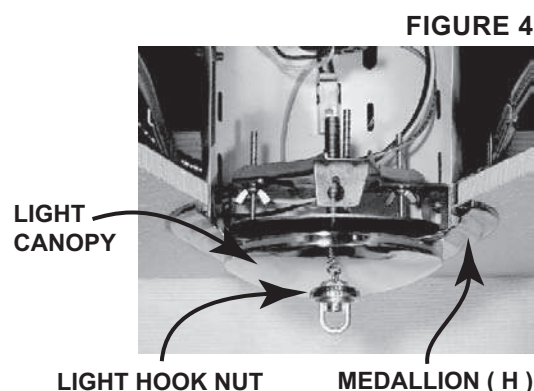
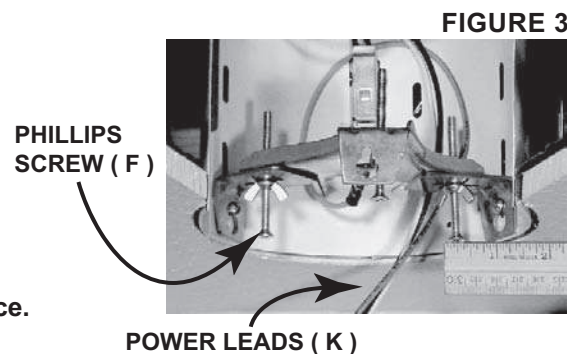
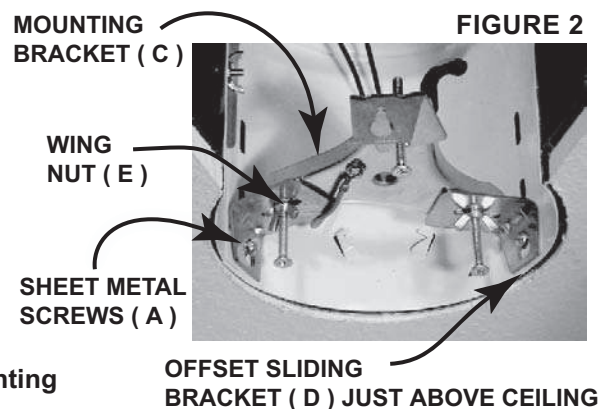
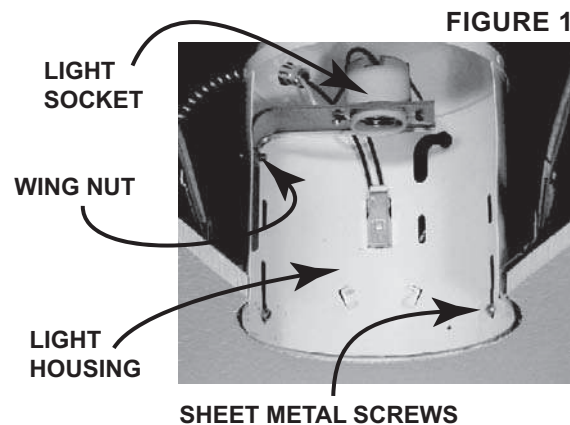

INSTALLATION USING FLAT MEDALLION:

PENDANT LIGHTS, TRACK LIGHTING, FLUSH MOUNT FIXTURES & CEILING FANS

COMPLETE STEPS 1-10 FOR HANGING LIGHT FIXTURE.

STEP 11. Insert power leads (K) through center hole on mounting bracket (C) then through threaded pipe (G). Screw threaded pipe (G) into center hole on mounting bracket (C) leaving pipe 1/4" below ceiling. Install upper nut (I) to secure threaded pipe (G) in place (SEE FIGURE 6).

STEP 12. Install mounting plate (J) and tighten snug against phillips screws (F). Install and tighten lower nut (I) (SEE FIGURE 7).

STEP 13. Place flat medallion (H) over mounting plate (J) and continue installation using instructions supplied with fixture. Use fixture to hold medallion in place. Figure 10 shows this accomplished using a fan hanger bracket.

UPPER NUT (I) **FIGURE 6**

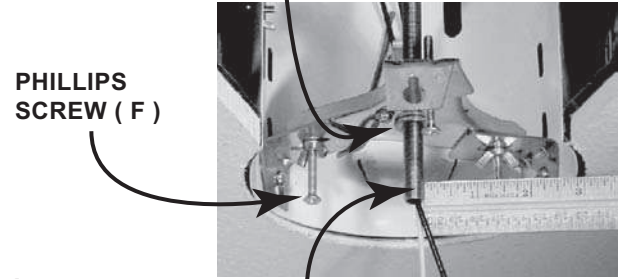

PHILLIPS
SCREW (F)

THREADED PIPE (G)

FIGURE 7

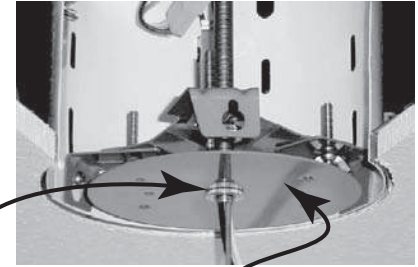

LOWER NUT (I)

MOUNTING PLATE (J)

FIGURE 8

INSTALLATION USING BEVELED MEDALLION:

PENDANT LIGHTS & CEILING FANS

COMPLETE STEPS 1-9 FOR HANGING LIGHT FIXTURE.

STEP 10. Insert power leads (K) through center hole on mounting bracket (C) then through threaded pipe (G). Screw threaded pipe (G) into center hole on mounting bracket (C).

STEP 11. Using medallion (H) as a guide place medallion (H) on ceiling and lower threaded pipe (G) to 1/4" below medallion then install and tighten nut (I) to secure in place (SEE FIGURE 8).

STEP 12. Measure distance from ceiling to inside of medallion (SEE FIGURE 9). loosen wing nuts (E) and lower phillips screws (F) to this measurement. Re-tighten wing nuts (E) to secure. Install mounting plate (J) making sure phillips screws touch mounting plate. then install nut (I) to secure in place.

STEP 13. Place medallion (H) over mounting plate (J) and continue installation using instructions supplied with fixture, use fixture to hold medallion in place. Figure 10 shows this accomplished using a fan hanger bracket.

MEDALLION (H)

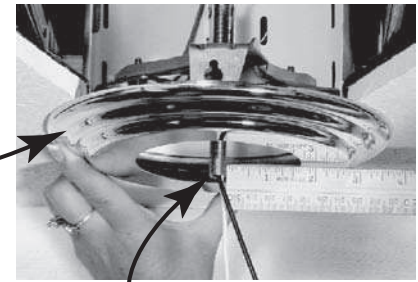

THREADED PIPE (G)

FIGURE 9

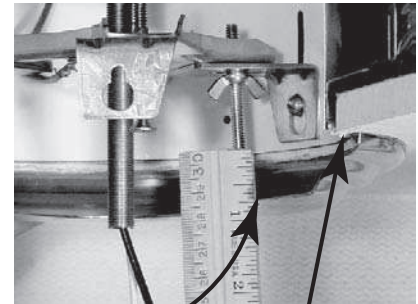

INSIDE OF
MEDALLION (H)

CEILING

FIGURE 10

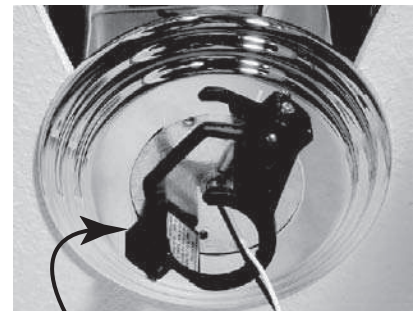

CEILING FAN HANGER BRACKET

Customer Support Monday thru Friday 9 to 5 PST 888-506-0527

JSB Enterprises

Temecula, CA 92590

www.thecanconverter.com

PAT 6,979,108

