

# **MYSON**

## TOWEL WARMERS

# 2004 Specification Guide

**To:** \_\_\_\_\_

**From:** \_\_\_\_\_

**Date:** \_\_\_\_\_

**Message:** \_\_\_\_\_

---

---

---

---

---

---

---

---

As requested, attached are 13 pages including cover. If you have questions, please do not hesitate to contact us at 800-698-9690. If you received this fax transmittal in error, please let us know.

- UL-listed
- up to 200 watts
- install easily
- back lit on/off switch
- wall and portable models
- most models are available in chrome, nickel, satin nickel, regal brass, satin brass, gold, satin gold plate, baked epoxy powdercoat white finishes or custom colors
- special order models and custom sizes available
- provided with necessary matching installation accessories
- 5 year Myson Warranty

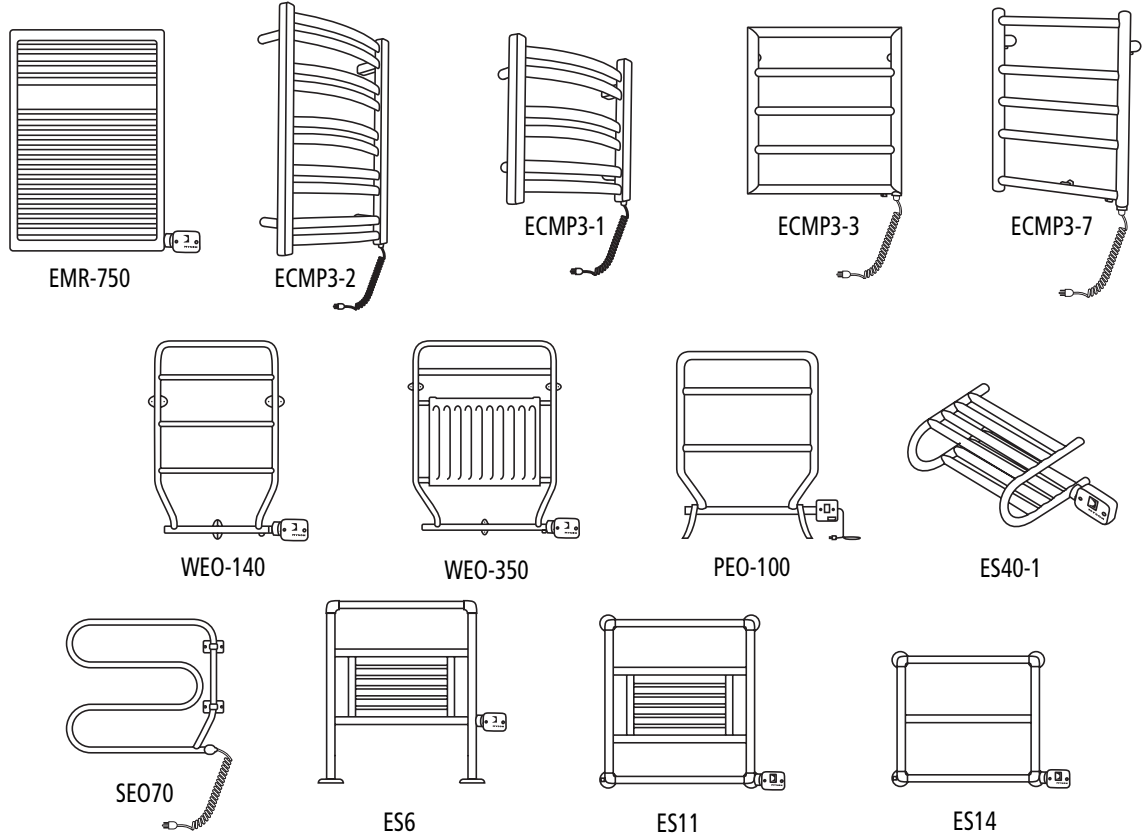

Model	V/Hz	Watts	Amps	Overall Height (in)	Overall Width (in)	Overall Width Incl. Electric Box (in)	Center of Flange to Wiring Conn. (in)	Width C to C Vert. Tubes (in)	Bottom Rail to Center of Flange (in)	Center Rt. Rail to Wire Conn. (in)	Overall Projection (in)	Tube Diameter (in)	Shipping Weight (lbs)	Special Order
EMR750	120V/60Hz	200	1.75	29-7/8	19-3/4	22-3/8	-	18-1/2	25-1/2	2	3-5/8	1-1/4 / 1	39	N/A
ECMP3/1'	120V/60Hz	70	0.63	19-7/8	17-1/4	-	-	15-1/4	-	-	5-1/4	1-1/4 / 1	20	N/A
ECMP3/2'	120V/60Hz	70	0.63	34	17-1/4	-	-	15-1/4	-	-	5-1/4	1-1/4 / 1	28	N/A
ECMP3/3'	120V/60Hz	70	0.63	21-3/4	19-5/8	-	-	18-1/4	17-1/2	-	3-7/8	1-1/4 / 1	24	N/A
ECMP3/7'	120V/60Hz	70	0.63	21-1/4	17-1/2	-	-	16-1/4	16-1/2	-	3-7/8	1-1/4 / 1	24	N/A
WEO100	120V/60Hz	100	0.76	24-1/4	23	23-3/4	10-3/4	20	14	-	4	1	21	N/A
WEO140	120V/60Hz	140	1.10	33-1/2	23	23-3/4	10-3/4	20	23-1/8	-	4	1	31	N/A
WEO165	120V/60Hz	165	1.26	33-1/2	33	33	11-3/4	29-3/4	20-1/4	-	4	1	37	N/A
WEO350	120V/60Hz	200	1.75	33-1/2	25-1/4	25-1/4	11-3/4	22	25-1/4	-	4-1/2	1	40	N/A
PEO100	120V/60Hz	100	0.76	27-3/4	23	23-3/4	-	20	-	-	4	1	21	N/A
PEO140	120V/60Hz	140	1.10	37	23	23-3/4	-	20	-	-	4	1	31	N/A
PEO165	120V/60Hz	165	1.26	37	33	33	-	29-3/4	-	-	4	1	37	N/A
PEO350	120V/60Hz	200	1.75	37	24-1/4	25-1/4	-	22	-	-	4-1/2	1	40	N/A
ES40/1	120V/60Hz	100	0.76	6-3/4	18-1/4	21-5/8	-	17	-	2-5/8	12	1-1/4	34	N/A
ES40/2	120V/60Hz	140	1.10	6-3/4	24-1/4	27-5/8	-	23	-	2-5/8	12	1-1/4	34	N/A
SEO70*	120V/60Hz	70	0.63	19-7/8	22-7/8	23 1/4	-	-	-	-	3-1/2	1	21	N/A
Flr. to Center Conn.														
ES6/1	120V/60Hz	165	1.26	36-5/8	27-1/4	30	-	24	12	2-5/8	Depends on Wall Stays	1-1/4	53	✓
ES6/2	120V/60Hz	165	1.26	36-5/8	33-1/4	36	-	30	12	2-5/8		1-1/4	62	✓
ES11/1	120V/60Hz	165	1.26	27-1/4	27-1/4	30	-	24	-	3	6-1/2	1-1/4	53	✓
ES11/2	120V/60Hz	165	1.26	33-1/4	33-1/4	36	-	30	-	3	6-1/2	1-1/4	62	✓
ES14/5	120V/60Hz	100	0.76	27	27	30	-	24	-	2-5/8	6-1/2	1-1/4	53	✓
ES14/6	120V/60Hz	100	0.76	27	33	36	-	30	-	2-5/8	6-1/2	1-1/4	53	✓

✓ Special order models are non-stock items. Please call Myson at 1-800-698-9690 for details.

\* SEO70 available in chrome and white only. †Pending Electric Approvals

# Classic Hydronic

- floor standing or wall-mounted
- 295 to 1442 BTU/hr
- chrome, nickel, satin nickel, regal brass, satin brass, gold, satin gold plate finishes
- also available in baked epoxy powdercoat white finish or custom colors
- manufactured from the highest quality de-zinc brass tubing
- provided with matching valves and sleeve kit
- 5 year Myson Warranty

Classic Towel Warmers are the perfect selection for both traditional and contemporary baths and are suitable for central heating or hot water circulating systems.

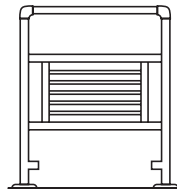

S6

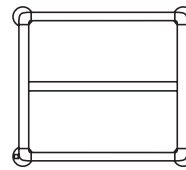

S14

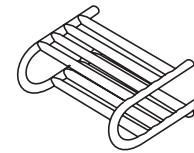

S40-1

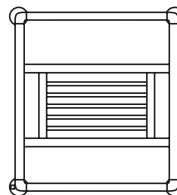

S11

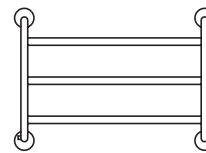

CYG14

Model	Btu/hr △85° F	Overall Height (in)	Overall Width Including Flanges (in)	Width C/C Vertical Tubes (in)	Center to Center Conn. (in)	Floor to Center Conn. (in)	Overall Projection (in)	Tube Diameter (in)	Shipping Weight (lbs)	Special Order ✓
S6/1	1,080	36-5/8	27-1/4	24	17-1/2	4-1/4	Depends on Wall Stays	1-1/4	48	N/A
S6/2	1,152	36-5/8	33-1/4	30	23-1/2	4-1/4		1-1/4	57	N/A
S6/3	1,224	36-5/8	39-1/4	36	29-1/2	4-1/4		1-1/4	68	✓
S6/4	1,296	36-5/8	45-1/4	42	35-1/2	4-1/4		1-1/4	77	✓
S11/1	1,143	27-1/4	27-1/4	24	17-1/2	—	6-1/2	1-1/4	48	N/A
S11/2	1,238	33-1/4	33-1/4	30	23-1/2	—	6-1/2	1-1/4	57	N/A
S11/3	1,362	33-1/4	39-1/4	36	29-1/2	—	6-1/2	1-1/4	77	✓
S11/4	1,442	33-1/4	45-1/4	42	35-1/2	—	6-1/2	1-1/4	77	✓
S14/1	475	27	27	24	17-3/4	—	6-1/2	1	48	N/A
S14/2	535	27	33	30	23-3/4	—	6-1/2	1	48	N/A
S14/3	598	27	39	36	29-3/4	—	6-1/2	1	68	✓
S14/4	636	33	39	36	29-3/4	—	6-1/2	1	68	✓
CYG14/1	295	27	27	24	17-3/4	—	5-1/2	1	30	—
CYG14/2	346	27	33	30	23-3/4	—	5-1/2	1	30	—
CYG14/3	396	27	39	36	29-3/4	—	5-1/2	1	30	—
CYG14/4	429	33	39	36	29-3/4	—	5-1/2	1	30	—

  

Model	BTU/hr	Overall Height (in)	Overall Width Including Flanges (in)	Center of Bottom Rail to Valve Center	Width C/C Vertical Tubes (in)	C/C Water Conn.	Overall Projection (in)	Tube Diameter (in)	Shipping Weight (lbs)	Special Order
S40/1	616	6-3/4	18-1/4	3-3/4	17	17	12	1-1/4	29	N/A
S40/2	720	6-3/4	24-1/4	3-3/4	23	23	12	1-1/4	29	N/A

✓ Special order for electric versions of this model. Please call Myson at 1-800-698-9690 for details. N/A-not available Valves are 3/4" Copper Compression

- UL-approved with back lit on/off switch
- up to 200 watts
- easy installation
- floor standing or wall-mounted
- chrome, nickel, satin nickel, regal brass, satin brass, gold, satin gold plate finish
- combination finishes include chrome/gold; chrome/regal brass; white/gold and more
- available in baked epoxy powdercoat white finish or a palette of 1200 colors
- special order models and custom sizes available
- provided with necessary matching installation accessories
- 5 year Myson Warranty

Premier Towel Warmers create a dramatic focal point for any wall...adding heat, elegance and style to any room. The new Premier Space-Saver model is perfect for small kitchens and guest bathrooms.

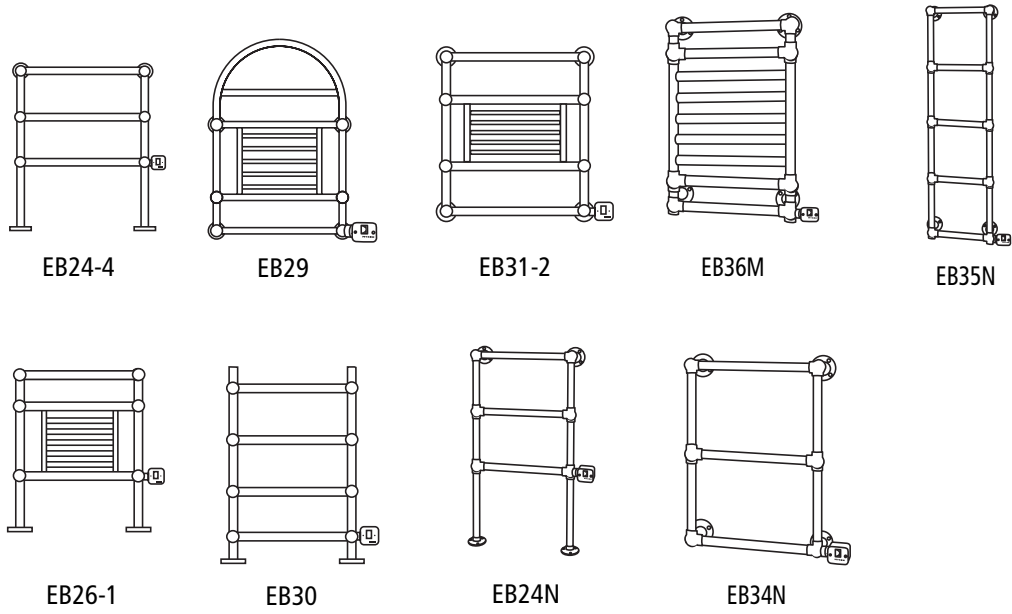

Model	V/Hz	Watts	Amps	Overall Height (in)	Overall Width Including Flanges (in)	Overall Width Incl. Elec. Box (in)	Width C/C Vertical Tubes (in)	Center of Rt. Rail to Wiring Conn. (in)	Floor to Center of Elec. Box (in)	Overall Projection (in)	Tube Diameter (in)	Approx. Shipping Weight (lbs)	Special Order
EB24/4	120V/60Hz	140	1.10	37-5/8	27-1/4	30	24	2-5/8	15	5-5/8	1-1/4	66	N/A
EB24/5	120V/60Hz	140	1.10	37-5/8	33-1/4	36	24	2-5/8	15	5-5/8	1-1/4	71	✓
EB24/6	120V/60Hz	140	1.10	37-5/8	39-1/4	42	30	2-5/8	15	5-5/8	1-1/4	71	✓
EB26/1	120V/60Hz	165	1.30	36-7/8	27-1/4	30	24	2-5/8	12		1-1/4	47	N/A
EB26/2	120V/60Hz	165	1.30	36-7/8	33-1/4	36	30	2-5/8	12		1-1/4	52	✓
EB26/3	120V/60Hz	165	1.30	36-7/8	39-1/4	42	36	2-5/8	12		1-1/4	52	✓
EB26/4	120V/60Hz	165	1.30	36-7/8	45-1/4	48	42	2-5/8	12		1-1/4	52	✓
EB29	120V/60Hz	165	1.30	41	27-1/4	30	24	3	—	5-1/2	1-1/4	66	N/A
EB30	120V/60Hz	200	1.75	39	27-1/4	30	24	2-5/8	4-1/4	8-3/4	1-1/4	79	N/A
EB31/1	120V/60Hz	165	1.30	27-1/4	27-1/4	30	24	3	—	5-5/8	1-1/4	52	✓
EB31/2	120V/60Hz	165	1.30	33-1/4	33-1/4	36	30	3	—	5-5/8	1-1/4	52	N/A
EB31/3	120V/60Hz	165	1.30	33-1/4	39-1/4	42	36	3	—	5-5/8	1-1/4	60	✓
EB31/4	120V/60Hz	165	1.30	33-1/4	45-1/4	48	42	3	—	5-5/8	1-1/4	60	✓
EB34/5	120V/60Hz	100	0.76	27-1/4	27-1/4	30	24	3	—	5-5/8	1-1/4	40	N/A
EB34/6	120V/60Hz	100	0.76	27-1/4	33-1/4	36	30	3	—	5-5/8	1-1/4	54	✓
EB34/7	120V/60Hz	140	1.10	27-1/4	39-1/4	42	36	3	—	5-5/8	1-1/4	71	✓
EB34/8	120V/60Hz	140	1.10	33-1/4	39-1/4	42	36	3	—	5-5/8	1-1/4	71	✓

Space-Saver Models													
EB24N	120V/60Hz	100	0.76	37-5/8	21-1/4	23-5/8	18	2-5/8	15	5-5/8	1-1/4	30	N/A
EB34N	120V/60Hz	100	0.76	27-1/4	21-1/4	23-5/8	18	3	—	5-7/8	1-1/4	30	N/A
EB35N	120V/60Hz	140	1.10	51-1/4	15-1/4	18	12	3	—	5-7/8	1-1/4	35	N/A
EB36M	120V/60Hz	165	1.30	27-1/4	21-1/4	24	18	3	—	5-7/8	1-1/4	35	N/A

✓ Special order models are non-stock items. Please call Myson at 1-800-698-9690 for details.

- from 333 to 1532 BTU/hr
- floor standing or wall-mounted
- manufactured from the highest quality de-zinc brass tubing
- chrome, nickel, satin nickel, regal brass, satin brass, gold, satin gold plate finish
- baked epoxy powdercoat white finish or custom colors
- combination finishes include chrome/gold; chrome/regal brass; white/gold and more
- custom sizes available
- suitable for central heating or hot water circulating systems
- provided with matching valves and sleeve kit
- 5 year Myson Warranty

Premier Towel Warmers make an elegant styling statement in any room. They are available in a wide range of stunning styles and are sized to keep your towels warm, remove humidity from the room, and add that extra needed warmth.

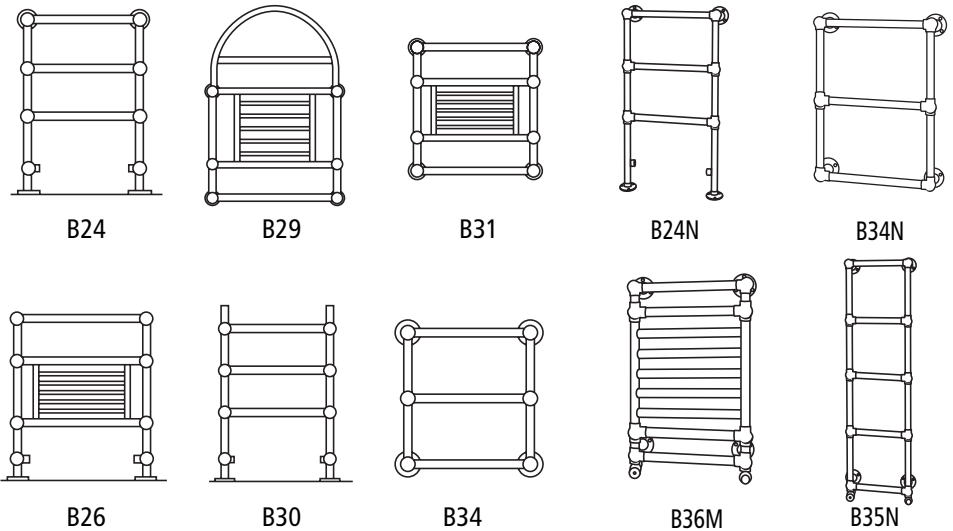

Model	Btu/hr Δ85° F	Overall Height (in)	Overall Width Including Flanges (in)	Width C/C Vertical Tubes (in)	Center to Center Conn. (in)	Valve Rough-in from Wall	Floor to Center Conn. (in)	Overall Projection (in)	Tube Diameter (in)	Shipping Weight (lbs)
B24/1	507	37-1/2	27	24	18	4-1/2	4-1/4	5-1/8	1	66
B24/2	568	37-1/2	33	30	24	4-1/2	4-1/4	5-1/8	1	66
B24/3	632	37-1/2	39	36	30	4-1/2	4-1/4	5-1/8	1	66
B24/4	600	37-5/8	27-1/4	24	18	4-1/2	4-1/4	5-3/8	1-1/4	66
B24/5	680	37-5/8	33-1/4	30	24	4-1/2	4-1/4	5-3/8	1-1/4	66
B24/6	752	37-5/8	39-1/4	36	30	4-1/2	4-1/4	5-3/8	1-1/4	66
B26/1	1080	36-7/8	27-1/4	24	18	—	4-1/4	Depends on Wall Stays	1-1/4	47
B26/2	1152	36-7/8	33-1/4	30	24	—	4-1/4		1-1/4	47
B26/3	1224	36-7/8	39-1/4	36	30	—	4-1/4		1-1/4	47
B26/4	1296	36-7/8	45-1/4	42	36	—	4-1/4		1-1/4	47
B29	1320	41	27-1/4	24	24	—	—	5-1/2	1-1/4	76
B30	1200	39	27-1/4	24	18	—	4-1/4	8-3/4	1-1/4	80
B31/1	1214	27-1/4	27-1/4	24	18	—	—	6-7/8	1-1/4	47
B31/2	1315	33-1/4	33-1/4	30	24	—	—	6-7/8	1-1/4	55
B31/3	1446	33-1/4	39-1/4	36	30	—	—	6-7/8	1-1/4	55
B31/4	1532	33-1/4	45-1/4	42	36	—	—	6-7/8	1-1/4	55
B34/1	505	27	27	24	18	—	—	6-5/8	1	49
B34/2	569	27	33	30	24	—	—	6-5/8	1	49
B34/3	634	27	39	36	30	—	—	6-5/8	1	49
B34/4	675	33	39	36	30	—	—	6-5/8	1	49
B34/5	606	27-1/4	27-1/4	24	18	—	—	6-7/8	1-1/4	49
B34/6	684	27-1/4	33-1/4	30	24	—	—	6-7/8	1-1/4	49
B34/7	760	27-1/4	39-1/4	36	30	—	—	6-7/8	1-1/4	66
B34/8	810	33-1/4	39-1/4	36	30	—	—	6-7/8	1-1/4	66

### Space-Saver Models

B24N	355	36-5/8	21-1/4	18	12	—	4-1/4	5-5/8	1-1/4	30
B34N	333	27-1/4	21-1/4	18	12	—	—	6-5/8	1-1/4	30
B35N	594	51-1/4	15-1/4	12	12	—	—	5-3/8	1-1/4	35
B36M	714	27-1/4	21-1/4	18	18	—	—	5-1/2	1-1/4	35

Valves are 3/4" Copper Compression

# Master Suite Electric

Master Suite Electric Towel Warmers are the ultimate in Period styling, adding both heat and drama to any room in your home.

- UL-listed with back lit on/off switch
- up to 500 watts
- wall and floor models
- chrome, nickel, satin nickel, regal brass, satin brass, gold, satin gold plate finish
- baked epoxy powdercoat white finish or custom colors
- combination finishes include chrome/gold; chrome/regal brass; white/gold and more
- provided with necessary matching installation accessories
- custom sizes available
- 5 year Myson Warranty

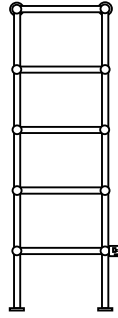

EB25

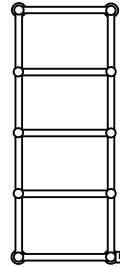

EB35

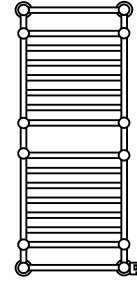

EB36

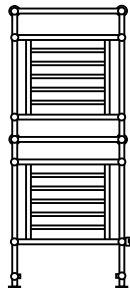

EB47

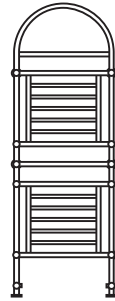

EB49

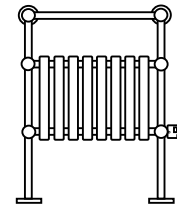

EVR1

Model	V/Hz	Watts	Amps	Overall Height (in)	Overall Width Incl. Flanges (in)	Overall Width Incl. Elec. Box (in)	Width C/C Vertical Tubes (in)	Center of Rt. Rail to Wiring Conn. (in)	Floor to Center of Elec. Box (in)	Overall Projection (in)	Tube Diameter (in)	Shipping Weight* (lbs)
EB25/1	120V/60Hz	200	1.75	61-5/8	21-1/4	23-5/8	18	2-5/8	12	5-3/8	1-1/4	150
EB25/2	120V/60Hz	200	1.75	61-5/8	27-1/4	29-5/8	24	2-5/8	12	5-3/8	1-1/4	150
EB25/3	120V/60Hz	300	2.73	61-5/8	33-1/4	35-5/8	30	2-5/8	12	5-3/8	1-1/4	150
EB35/1	120V/60Hz	200	1.75	51-1/4	21-1/4	24	18	3	—	6-7/8	1-1/4	150
EB35/2	120V/60Hz	200	1.75	51-1/4	27-1/4	30	24	3	—	6-7/8	1-1/4	150
EB35/3	120V/60Hz	300	2.73	51-1/4	33-1/4	36	30	3	—	6-7/8	1-1/4	150
EB36/1	120V/60Hz	300	2.73	51-1/4	21-1/4	24	18	3	—	6-7/8	1-1/4	150
EB36/2	120V/60Hz	300	2.73	51-1/4	27-1/4	30	24	3	—	6-7/8	1-1/4	150
EB47/1	120V/60Hz	300	2.73	68-3/8	27-1/4	29-5/8	24	2-5/8	12	5-3/8	1-1/4	150
EB47/2	120V/60Hz	300	2.73	68-3/8	33-1/4	35-5/8	30	2-5/8	12	5-3/8	1-1/4	150
EB49	120V/60Hz	300	2.73	73-1/2	27-1/4	29-5/8	24	2-5/8	12	5-3/8	1-1/4	150
EVR-1	120V/60Hz	500	4.2	37-1/2	26-3/4	29	23-7/16	2-3/8	11-1/2	8-1/8	1-1/4	75

\*150 lb. minimum must ship via truck

# Master Suite Hydronic

Master Suite Hydronic Towel Warmers add character, charm and elegance. Featuring traditional styling and beauty, this Collection is the ultimate in quality and craftsmanship.

- Floor-standing or wall-mounted models
- up to 2520 BTU/hr
- manufactured from the highest quality de-zinc brass tubing
- chrome, nickel, satin nickel, regal brass, satin brass, gold, satin gold plate finish
- baked epoxy powdercoat white finish or custom colors
- combination finishes include chrome/gold; chrome/regal brass; white/gold and more
- custom sizes available
- suitable for central heating or hot water circulating systems
- provided with matching cross-handle valves and sleeve kit
- 5 year Myson Warranty

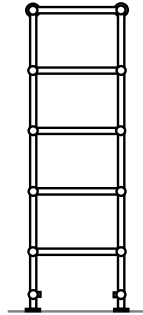

B25

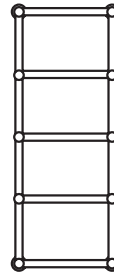

B35

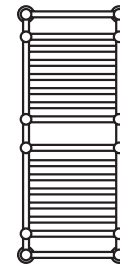

B36

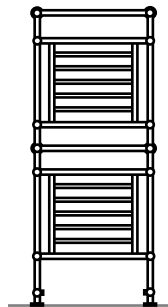

B47

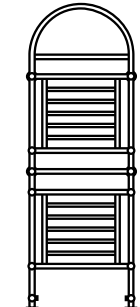

B49

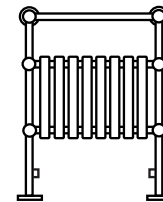

VR1

Model	Btu/hr △85° F	Overall Height (in)	Overall Width Including Flanges (in)	Width C/C Vertical Tubes (in)	Center to Center Conn. (in)	Floor to Center Conn. (in)	Valve Rough-in from Wall	Overall Projection (in)	Tube Diameter (in)	Shipping Weight* (lbs)
B25/1	736	61-5/8	21-1/4	18	12	4-1/4	4-3/8	5-3/8	1-1/4	150
B25/2	848	61-5/8	27-1/4	24	18	4-1/4	4-3/8	5-3/8	1-1/4	150
B25/3	960	61-5/8	33-1/4	30	24	4-1/4	4-3/8	5-3/8	1-1/4	150
B35/1	660	51-1/4	21-1/4	18	18	—	—	6-7/8	1-1/4	150
B35/2	776	51-1/4	27-1/4	24	24	—	—	6-7/8	1-1/4	150
B35/3	880	51-1/4	33-1/4	30	30	—	—	6-7/8	1-1/4	150
B36/1	1344	51-1/4	21-1/4	18	18	—	—	6-7/8	1-1/4	150
B36/2	1704	51-1/4	27-1/4	24	24	—	—	6-7/8	1-1/4	150
B36/3	2064	51-1/4	33-1/4	30	30	—	—	6-7/8	1-1/4	150
B47/1	1904	68-3/8	27-1/4	24	18	4-1/4	4-3/8	5-3/8	1-1/4	150
B47/2	2040	68-3/8	33-1/4	30	24	4-1/4	4-3/8	5-3/8	1-1/4	150
B49	2000	73-1/2	27-1/4	24	18	4-1/4	4-3/8	5-3/8	1-1/4	150
VR1	2520	37-1/2	26-3/4	23-1/2	17-1/8	4-1/4	4-1/8	8-1/8	1-1/4	60

Valves are 3/4" Copper Compression

\*150 lb. minimum must ship via truck

# Multi-Rail, Aloha & ECO Electric

- wall-mounted models
- manufactured from the highest quality materials
- heat output for warming towels and the room
- up to 700 watts of power
- chrome, nickel, satin nickel, regal brass, satin brass, gold, satin gold plate finish
- available in baked epoxy powdercoat white finish or custom colors
- provided with necessary matching installation accessories
- ERR models available with matching optional towel rail for extra hanging space
- 5 year Myson Warranty

Multi-Rail, ECO & Aloha electric Towel Warmers, with their simple lines and large sizing, will meet any space or warmth requirement.

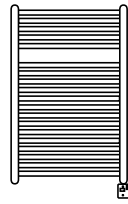

ERR1

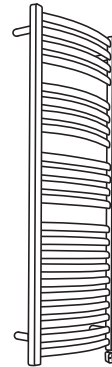

ECM4

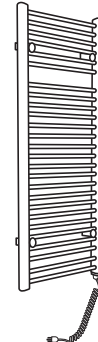

EECOS125

## Multi-Rail Electric

Model	V/Hz	Watts	Amps	Overall Height (in)	Overall Width Including Elec. Box (in)	Width C/C Vertical Tubes (in)	Overall Projection (in)	Tube Diameter (in)	Shipping Weight* (lbs)	
ERR1	120Volt/60Hz	300	2.73	33	20	18-1/2	4	1-1/4" Vertical Tubes	41	
ERR2	120Volt/60Hz	300	2.73	33	24	22-1/2	4		47	
ERR3	120Volt/60Hz	300	2.73	33	30	28-1/4	4		58	
ERR4	120Volt/60Hz	500	4.20	50	20	18-1/2	4		61	
ERR5	120Volt/60Hz	500	4.20	50	24	22-1/2	4		70	
ERR6	120Volt/60Hz	500	4.20	50	30	28-1/4	4		84	
ERR7	120Volt/60Hz	700	6.37	74	20	18-1/2	4		1" Horizontal Tubes	150
ERR8	120Volt/60Hz	700	6.37	74	24	22-1/2	4			150
ERR9	120Volt/60Hz	700	6.37	74	30	28-1/4	4			150

## Aloha Models Electric

ECM1	120Volt/60 Hz	300	2.73	31-1/4	19-3/4	17-1/2	5-1/4	1-1/2" Vertical "D" Tubes	41
ECM2	120Volt/60 Hz	300	2.73	31-1/4	23-5/8	21-3/8	5-1/4		47
ECM3	120Volt/60 Hz	300	2.73	31-1/4	29-1/2	27-1/4	5-1/4		58
ECM4	120Volt/60 Hz	500	4.20	49-3/4	19-3/4	17-1/2	5-1/4	1" Oval Horizontal Tubes	61
ECM5	120Volt/60 Hz	500	4.20	49-3/4	23-5/8	21-3/8	5-1/4		70
ECM6	120Volt/60 Hz	500	4.20	49-3/4	29-1/2	27-1/4	5-1/4		84
ECM7	120Volt/60 Hz	700	6.37	75-3/4	19-3/4	17-1/2	5-1/4		150
ECM8	120Volt/60 Hz	700	6.37	75-3/4	23-5/8	21-3/8	5-1/4		150
ECM9	120Volt/60 Hz	700	6.37	75-3/4	29-1/2	27-1/4	5-1/4		150

## Eco Models Electric Pending Electric Approvals

EECOS-85	120Volt/60 Hz	300	2.73	34	19-5/8	17-3/4	4	1-1/2" Vertical "D" Tubes	40
EECOS-86	120Volt/60 Hz	300	2.73	34	23-5/8	21-5/8	4		45
EECOS-125	120Volt/60 Hz	300	2.73	48-1/4	19-5/8	17-3/4	4		60
EECOS-126	120Volt/60 Hz	300	2.73	48-1/4	23-5/8	21-5/8	4	1" Horizontal Tubes	70
EECOS-185	120Volt/60 Hz	500	4.20	71-1/8	19-5/8	17-3/4	4		150
EECOS-186	120Volt/60 Hz	500	4.20	71-1/8	23-5/8	21-5/8	4		150

\*150 lb. minimum must ship via truck

# Multi-Rail, Aloha & ECO Hydronic

- wall-mounted
- from 972 to 4178 BTU/hr
- manufactured from the highest quality materials
- heat output for warming towels and the room
- chrome, nickel, satin nickel, regal brass, satin brass, gold, satin gold plate finish
- available in baked epoxy powdercoat white finish
- provided with necessary installation accessories
- MRR models available with matching optional towel rail for extra hanging space
- 5 year Myson Warranty

Multi-Rail, Eco & Aloha hydronic Towel Warmers are the elegant solution to warming towels and keeping the humidity level down and dampness out.

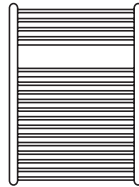

MRR1



CMR4

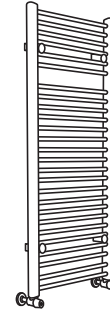

COS125

## Multi-Rail Hydronic Brass Construction

Model	Btu/hr △85° F	Optional Additional Towel Rail	Overall Height (in)	Overall Width (in)	Width C/C Vertical Tubes (in)	Center to Center Conn. (in)	Overall Projection (in)	Tube Diameter (in)	Shipping Weight* (lbs)
MRR1	1284	MRAC 1	29-7/8	19-3/4	18-1/2	18-1/2	3-7/8	1-1/4" Vertical Tubes	25
MRR2	1523	MRAC 2	29-7/8	23-5/8	22-1/2	22-1/2	3-7/8		30
MRR3	1881	MRAC 3	29-7/8	29-1/2	28-1/4	28-1/4	3-7/8		35
MRR4	1873	MRAC 1	46-7/8	19-3/4	18-1/2	18-1/2	3-7/8	1" Horizontal Tubes	40
MRR5	2238	MRAC 2	46-7/8	23-5/8	22-1/2	22-1/2	3-7/8		45
MRR6	2786	MRAC 3	46-7/8	29-1/2	28-1/4	28-1/4	3-7/8		50
MRR7	2819	MRAC 1	70-7/8	19-3/4	18-1/2	18-1/2	3-7/8	1" Horizontal Tubes	150
MRR8	3363	MRAC 2	70-7/8	23-5/8	22-1/2	22-1/2	3-7/8		150
MRR9	4178	MRAC 3	70-7/8	29-1/2	28-1/4	28-1/4	3-7/8		150

## Aloha Hydronic Brass Construction

CMR1	972	N/A	28-1/2	19-1/4	17-1/2	17-5/8	5-1/2	1-1/2" Vertical "D" Tubes	39
CMR2	1150	N/A	28-1/2	23-1/4	21-3/8	21-1/2	5-1/2		45
CMR3	1419	N/A	28-1/2	29-1/8	27-1/4	27-3/8	5-1/2		56
CMR4	1637	N/A	47	19-1/4	17-1/2	17-5/8	5-1/2	1" Oval Horizontal Tubes	59
CMR5	1938	N/A	47	23-1/8	21-3/8	21-1/2	5-1/2		68
CMR6	2391	N/A	47	29-1/8	27-1/4	27-3/8	5-1/2		82
CMR7	2590	N/A	73	19-1/4	17-1/2	17-5/8	5-1/2	1" Horizontal Tubes	150
CMR8	3070	N/A	73	23-1/4	21-3/8	21-1/2	5-1/2		150
CMR9	3789	N/A	73	29-1/8	27-1/4	27-3/8	5-1/2		150

## Eco Hydronic Steel Construction

COS85	1302	N/A	34	19-5/8	17-3/4	17-3/4	4	1-1/2" Vertical "D" Tubes	39
COS86	1525	N/A	34	23-5/8	21-5/8	21-5/8	4		45
COS125	1804	N/A	48-1/4	19-5/8	17-1/2	17-3/4	4	1" Horizontal Tubes	59
COS126	2120	N/A	48-1/4	23-5/8	21-5/8	21-5/8	4		68
COS185	2720	N/A	71-1/8	19-5/8	17-1/2	17-3/4	4		150
COS186	3190	N/A	71-1/8	23-5/8	21-5/8	21-5/8	4	150	

Valves are 1/2" Copper Compression

\* 150 lb. minimum must ship via truck

# Tempo Hydronic

- hydronic models
- manufactured from the highest quality de-zinc brass tubing
- 893 to 2478 BTU/hr
- chrome, nickel, satin nickel, regal brass, satin brass, gold, satin gold plate finish
- baked epoxy powdercoat white finish or custom colors
- provided with matching valves and sleeve kit
- Serenade available as an inside corner model or custom order as an outside corner (page 21)
- decorative "finial"
- 5 year Myson Warranty

The Tempo Collection has been styled with the designer in mind, presenting the best of both European contemporary styling and elegance. Hydronic only. Brass Construction

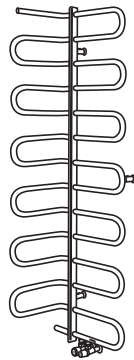

SEN2



SON1

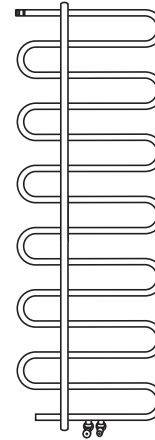

CAD2

## Serenade Hydronic Brass Construction

Model	Btu/hr △85° F	Overall Height (in)	Overall Width (in)	Overall Depth (in)	Number of Tubes	Overall Projection (in)	C/C Connections* (in)	Shipping Weight* (lbs)	Special Order
SEN1	993	39	20-1/16	11-7/8	N/A	3-3/8	2-1/8	50	N/A
SEN2	1873	70-7/8	20-1/16	11-7/8	N/A	3-3/8	2-1/8	150	N/A
SEN01	993	39	20-1/16	11-7/8	N/A	3-3/8	2-1/8	50	N/A
SEN02	1873	70-7/8	20-1/16	11-7/8	N/A	3-3/8	2-1/8	150	N/A

## Sonata Hydronic Brass Construction

SON1	993	70-7/8	6-1/2	—	4	3-3/8	2-3/4	30	N/A
SON2	1474	70-7/8	9-1/4	—	6	3-3/8	5-3/4	35	N/A
SON3	1978	70-7/8	12-1/8	—	8	3-3/8	8-1/2	40	N/A
SON4	2478	70-7/8	15	—	10	3-3/8	11-3/8	50	N/A

## Cadence Hydronic Brass Construction

CAD1	893	39	23-5/8	—	N/A	3-3/8	2-1/8	30	N/A
CAD2	1585	70-7/8	23-5/8	—	N/A	3-3/8	2-1/8	50	N/A

\*Rough in = 1/2" copper compression \*150 lb. minimum must ship via truck

# Melody Hydronic

- Gavotte and Rhapsody available in Chrome, Regal Brass or Gold Plate
- BTU range from 1024 to 3489
- Cavatine, Interlude and Maestro available in baked epoxy powdercoat white finish
- provided with matching valves and sleeve kit
- 5 year Myson Warranty

The Melody Collection is a designer's dream...a stunning and dramatic focal point. Manufactured from high quality alloy steel, they are only appropriate for closed-loop heating systems.

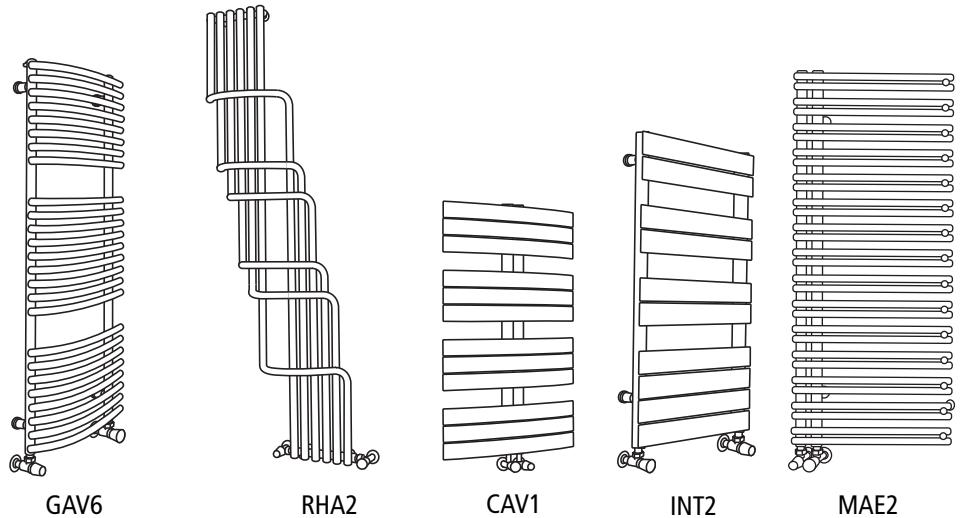

## Gavotte Hydronic Steel Construction

Model	Btu/hr Δ85° F	Overall Height (in)	Overall Width (in)	Variable Projections (in)	C/C Connections* (in)	Shipping Weight (lbs)
GAV1	1376	29-3/4	19-11/16	5-3/4 - 6-1/4	15-3/4	40
GAV2	1610	29-3/4	23-5/8	6-1/8 - 6-5/8	19-1/2	46
GAV3	2113	48	19-11/16	5-3/4 - 6-1/4	15-3/4	52
GAV4	2468	48	23-5/8	6-1/8 - 6-5/8	19-1/2	58
GAV5	2973	69-1/2	19-11/16	5-3/4 - 6-1/4	15-3/4	64
GAV6	3489	69-1/2	23-5/8	6-1/8 - 6-5/8	19-1/2	70

## Rhapsody Hydronic Steel Construction

RHA1	1674	49-1/4	22-1/2	8-7/8 - 9-3/8	12-1/2	60
RHA2	2294	63	25	9-7/8 - 10-3/8	13-1/2	82

## Cavatine Hydronic Steel Construction

CAV1	2528	44-1/2	25-9/16	4-1/2 - 4-7/8	2-1/8	40
CAV2	3294	56-5/16	25-9/16	4-1/2 - 4-7/8	2-1/8	60

## Interlude Hydronic Steel Construction

INT1	1024	20-7/8	19-11/16	4-1/4 - 4-7/8	17-5/8	40
INT2	1692	38-5/8	19-11/16	4-1/4 - 4-7/8	17-5/8	48
INT3	2506	59-1/4	19-11/16	4-1/4 - 4-7/8	17-5/8	54

## Maestro Hydronic Steel Construction

MAE1	1512	31-5/16	19-5/8	3-7/8 - 4-3/8	2-1/8	42
MAE2	2208	47-1/16	19-5/8	3-7/8 - 4-3/8	2-1/8	48
MAE3	3070	69-5/32	19-5/8	3-7/8 - 4-3/8	2-1/8	54

All products in the Melody Collection are designed for closed-loop heating system.

\*Rough in = 1/2" copper compression

# Shower Curtain Rails

■ Available in the following finishes:

- Chrome
- Nickel
- Regal Brass
- Gold
- Satin Nickel
- Satin Brass
- Satin Gold
- Custom Colors

- One inch diameter brass tube construction for elegance and strength
- Tailor-made rails can be manufactured to your personal requirements
- Fixed or adjustable (optional) ceiling stays on all rails

MYSON Shower Curtain Rails use the same high quality brass as our Classic, Premier and Master Suite Towel Warmers. Each Shower Curtain Rail is manufactured and finished to the same exacting standards and will give your bathroom the feel of quality and elegance that you deserve.

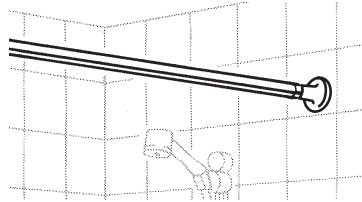

**CR1**

- Straight Rail
- One fixed and one loose flange
- Sizes: 48"  
60"  
72"  
84"

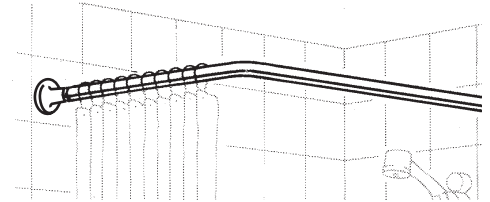

**CR2**

- "L" Shaped Rail
- Two fixed flanges
- Sizes: 30" x 30"  
30" x 36"  
36" x 36"  
42" x 24" (includes one 18" ceiling stay)

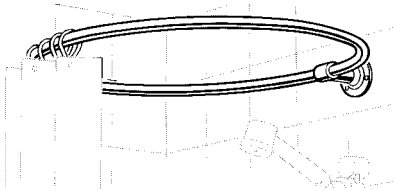

**CR3**

- Circular Rail
- One fixed flange
- Size: 30" diameter

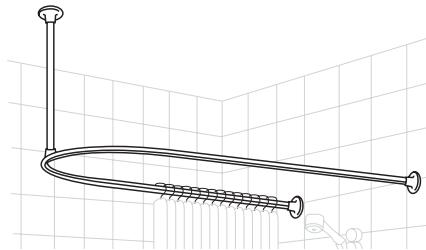

**CR4**

- "U" Shaped Rail
- Two fixed wall flanges with One fixed ceiling stay: height 18"
- Adjustable length ceiling stay from 3" to 18" is available
- Ceiling stay longer than 18" is available but is special order
- Size: 48" x 28"

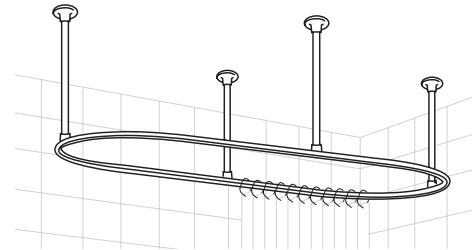

**CR5**

- Oval Rail
- Standard: Four fixed ceiling stays: height 18"
- Adjustable length ceiling stays from 3" to 18" are available
- Ceiling stays longer than 18" are available but are special order
- Size: 60" x 28"

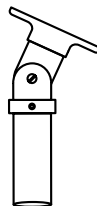

CR4 & CR5 optional angled flange now available for sloping ceilings — must be specified at time of order

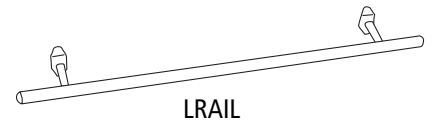

LRAIL



GSHELF

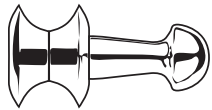

TPEG1

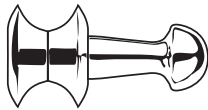

TPEG2

Code	Description	Fits Model	Page	Code	Description	Fits Models	Page
TPEG1	Towel Peg	Maestro	23	MRAC1	Rack	MRR1, MRR4, MRR7, EMR750	19, 5
TPEG2	Towel Peg	Gavotte	23	MRAC2	Rack	MRR2, MRR5, MRR8	19
LRAIL	Laundry Rail	Maestro	23	MRAC3	Rack	MRR3, MRR6, MRR9	19
GSHELF	Glass Shelf	Maestro	23	KM2ST-1G	1-Gang 24 hr single wall plate		26
PTR	Towel Rack	EO350	5	KM2ST-2G	2-Gang 24 hr timer; 1 light switch		26
				KM2ST-3G	3-Gang 24 hr timer; 2 light switch		26

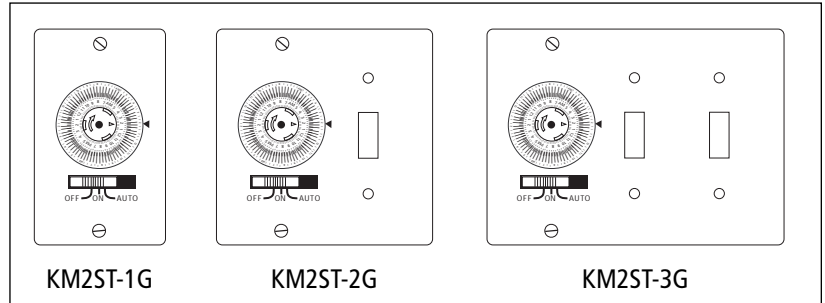

24-Hour Programmable Timers

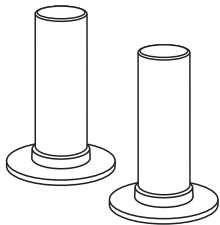

Sleeve Kit

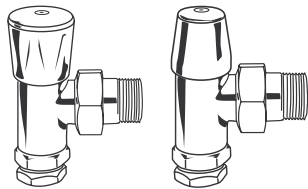

Premier, Classic and Melody Valves

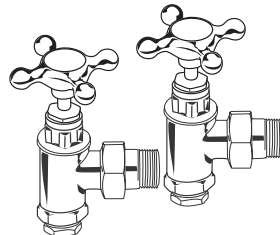

Master Suite Valves

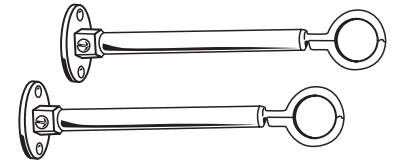

Wall Stays for models B26, EB26, S6, ES6, adjustable from 2 1/2" to 7"

## Warranty

MYSON warrants your Towel Warmer for a Full Five Years against the following manufacturing defects:

1. MYSON warrants the plated or painted finish of your Towel Warmer to be free of manufacturing defects for five years from the date of installation. This means your Towel Warmer finish will not crack, split, peel or flake from the surface of the rails.
2. MYSON warrants the brazed connections and the tubing of your Towel Warmer to be free from leaks for five full years from the date of installation.

For complete Warranty information, please contact Myson at 1-800-698-9690.

MYSON will repair or replace at our discretion any product which fails under these categories. We do not accept liability for any labor cost involved. Should a problem occur, please do not hesitate to contact us.

We wish you years of satisfaction and comfort from your MYSON Towel Warmer.

**MYSON**

**1-800-698-9690**

948 Hercules Drive  
Colchester, VT 05446  
Fax: 802-654-7022

**www.MysonInc.com**

In accordance with our policy of continual product improvement, we reserve the right to amend specifications without prior notification