

# GJK Assembly Instructions

## Grill Assembly Instructions

- *The GJK 36" Series Grill Model is almost completely factory assembled.*
- *Assembly is required for: The locking casters, side shelves, condiment holders, doors, hole plugs, grates and briquets.*
- *Please consult the Owner's manual for additional pertinent information regarding important general safety rules, maintenance, troubleshooting, etc.*
- *Leak test all gas connections before using.*
- *Caution: Combustible material should never be within 24 inches of the top, bottom, back or sides of your MHP Gas Barbecue Grill.*

### Complete View of GJK Grill



### Step 1: Locking Casters (See Fig. 1)

The locking casters are packed with the side shelves. Lift one end of the grill about 12 inches and block it so it won't fall. Simply push the casters up into the corner pocket brackets until they bottom out. Some resistance will be felt so the casters may have to be tapped up with a block of wood. They should also bottom out when the grill is set back down. The casters are locked when the foot tab is in the down position.

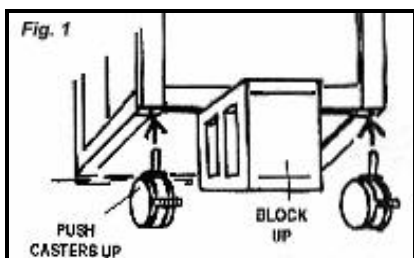

### Step 2: Side Shelves (See Fig. 2)

The side shelves are attached to the main cart with four ¼ - 20 X ½" bolts and split washers. Simply install one (1) upper bolt (w/washer) loosely and let the shelf hang. Then lift, pivoting the shelf while the remaining bolts and washers are put in and tightened.

### Step 3: Condiment Holders (See Fig. 2)

Condiment Holders are attached to the front of the side shelves using the two 10-24 x ½" Stainless Steel Carriage Bolts and Kep nuts for each holder.

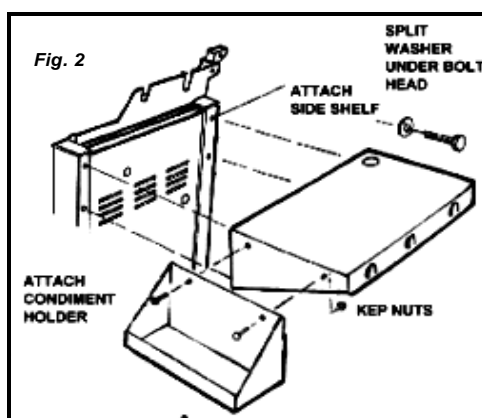

### Step 4: Attaching the Doors (Fig. 3)

The doors simply drop onto the hinge pins. Hold the door in the open position (straight out from the grill front) and carefully match the hinge pins to the door hinges and push down.

The bottom catch is magnetic, the top catch is a mechanical pull catch. On the inside of the right hand door install the wire condiment holder using two (2) 10-24 x ½" bolts and nuts. Tuck the horizontal wire hooks behind the door edge.

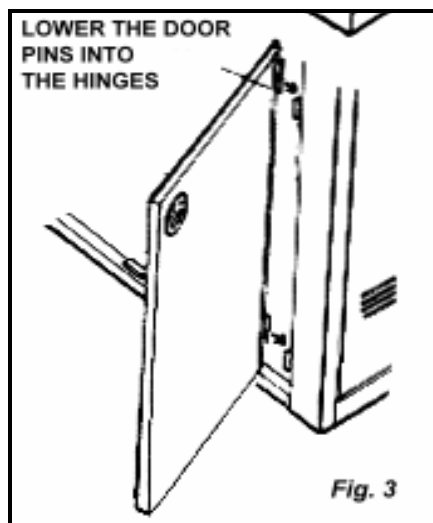

# GJK Assembly Instructions

## Step 5: Panel Hole Plugs (See Fig. 4)

Install the three (3) large block panel Hole Plugs and one (1) medium right Side Shelf Hole Plug. Press in until they lock. These can be removed later if installing a Side Burner or a Rotisserie Burner. NOTE: NATURAL GAS MODELS will have a rubber grommet installed in the lower Back Panel hole for the 12 ft. long hose to pass through. This will leave only two Side Panels that need plugs.



## Step 6: Remove Plastic Protective Film

Carefully peel away any remaining white plastic protective film. Dirt and finger prints may be cleaned off with a warm soapy water solution or the enclosed "Flitz" Cleaner, however, please note that stainless steel is very difficult to "spot clean". This is true of all stainless steel and especially when new. It is hard to clean one spot without noticing the cleaned area. One might be able to clean a whole panel area easier than one spot on a panel.

The MHP STAINLESS CLEANER is excellent at removing the gold patina that will develop over time on the hood from heat. The Cleaner will also help prevent future heat stains. Be sure to follow directions carefully. DO NOT let the Cleaner dry on the surface. You must have a wet cloth ready to remove the applied Cleaner, then buff with a dry cloth.

## Step 7: Before Lighting The Grill (Fig. 5)

Before lighting the grill, especially for the first time, check the venturi to orifice engagement to make sure that shipping has not dislodged the burner placement. The Venturis should extend over each valve about 1/4" to 7/8" (and there are four (4) to check).

## ORIFICE ENGAGEMENT

At the end of each valve there is a tiny gas opening known as an orifice. Gas exits the orifice and enters a venturi where it mixes with air coming in the side air shutter. The proper mixture of air and gas produces a clean blue flame at the burner.

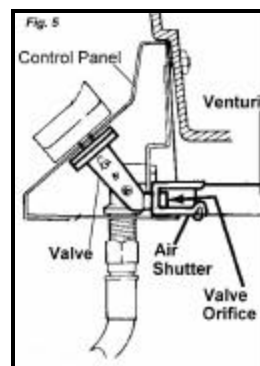

**WARNING!** Always check the alignment of the orifice and the venturi whenever the grill has been moved. Make sure that the orifice fits into the venturi tube 1/4" to 1/2". See illustration above.

## Step 8: Electronic Pushbutton (See Fig. 6)

The Electronic Pushbutton Igniter is supplied with an "AA" Battery which should last several months, depending on use. Battery placement is easily accomplished by unscrewing the silver pushbutton. The button, with battery attached, will be in your hand. The igniter mechanism remains in place held with a large nut. Replace the battery in the same orientation, insert battery and screw pushbutton on.

**DO NOT OVERTIGHTEN** the pushbutton when reinstalling — just finger tighten.

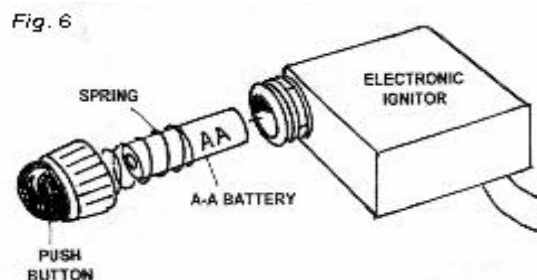

# GJK Assembly Instructions

## Step 9: Rock Grates (See Fig. 7)

Install the Rock Grates and arrange the Briquets in an alternating, interweaved pattern. Start at the back row and continue forward and across until the grate is covered. This pattern will minimize the amount of grease that will reach the burner ports.

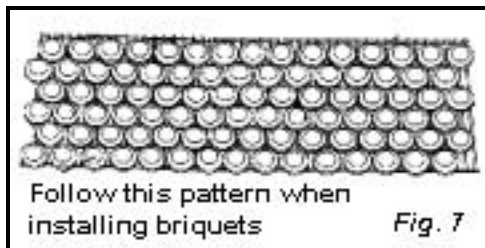

## Step 10: Gaslow Fuel Monitor & Leak Detector (Fig. 8)

If so supplied, the small access door on the upper corner of the left panel will need to be removed to install the exclusive Uprfront Gaslow Fuel Monitor & Leak Detector.

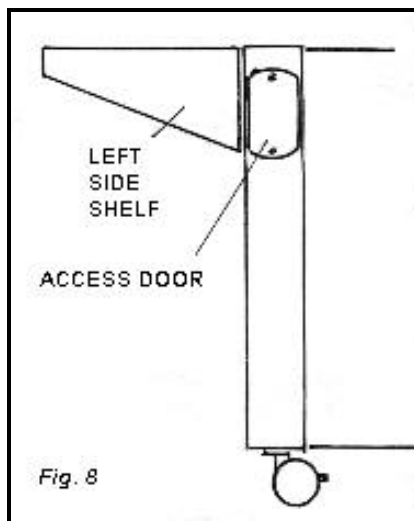

# GJK Parts Information

Parts are divided below into lists associated with the three different grill configurations . When ordering a part please provide the grill Identification, part number, quantity and product description. To order contact your local MHP dealer or MHP's customer service: phone: 1-888-647-4745, fax: 1-800-637-2918, or E-mail: mhp@voyager.net for the dealer nearest you.

Item	Qty.	Part #	Description
1	1	KK-CP	Control Panel
2	1	KK-UBP	Upper Back Panel
3	1	KK-LBP	Lower Back Panel
4	1	KK-FP	Front Pit
5	1	KK-BP	Back Pit
6	1	KK-SSR	Right Side Shelf
7	1	KK-SSL	Left Side Shelf
8	2	KK_CH	Condiment Holder
9	1	KK-EPL	End Panel (Left)
10	1	KK-EPR	End Panel (Right)
11	1	KK_BAS	Lower Base
12	1	KK-DC	Door Catch
13	1	KK-BRC	Braces (Not Visible)
14	1	KK-DL	Left Door (Not Shown)
15	1	KK-DR	Right Door
16	2	KK-BS	Burner Support
17	1	KK-GT	Grease Tray (Full Width)
18	1	KK-TSI	Stainless Hood
19	1	KK-TECL	Top Left End Casting
20	1	KK-TECR	Top Right End Casting
21	1	KK-BECL	Bottom Left End Casting
22	1	KK-BECR	Bottom Right End Casting
23	4	KK-CB	Caster Receptacle
24	4	KK-WL	Locking Casters
25	1	KK-DEF	Ignitor Shield
26	1	KK-IP	Instruction Panel
27	4	KK-SSB 2	Stainless Steel Bezel
28	4	KK-K10	Control Knob
29	1	KK-EIB	Electronic Module
30	2	KK-IW	Ignitor Wire
31	2	GG-IB	Spark Collector Box
32	2	HH-DSB	Stainless Steel Burner
33	2	KK-DV 13	Venturi
34	2	HH-Grate P	Rock Grate
35	112	GG-BQ#R	Briquets
36	2	KK-DPL	Door Pull
37	1	KK-DCH	Door Condiment Holder
38	4	KK-PEC	Panel Caps
39	1	KK-GSH	Perforated Stainless Steel Handle
40	1	KK-MAN P	Propane Manifold Assembly
	1	KK-MAN N	Natural Manifold Assembly
41	3	---	Large Access Hole Plug
42	1	---	Disposable Grease Tray
43	1	---	Small Access Plug
44	2	LPP	Lid Hinge Pin
45	2	LPP1	Pin Clip
46	1	---	Pin Clip
47	1	GG-TLG	MHP Logo
48	4	BR-SG	Spider Guard (on each venturi)
49	1	BRMPI	Meat Prop Temperature Gauge
50	1	BRSCC	Stainless Steel Cleaner (MHP)
50A	1	BRFSCC	Stainless Steel Cleaner (Flitz)

Item	Qty.	Part #	Description
<b>GJK-N ONLY</b>			
51	3	GG-SS-GRID	Stainless Steel Grid
52	1	KK-TS	Stainless Steel Warming Rack
53	1	ASCPL 2	12 Ft. Natural Gas Hose
54	1	ASCPL 3	Quick Disconnect Coupler
55	1	ASCPL 4	Dust Plug
56	1	ASCPL 5	Dust Plug
<b>GJK-NS ONLY</b>			
57	2	GG-GRID-S	SearMagic Grid (8" wide)
58	2	HH-GRID-S	SearMagic Grid (10" wide)
59	1	KK-TSS	SearMagic Warming Rack
Also #53-56 same as above			
<b>GJK-P ONLY</b>			
51	3	GG-SS-GRID	Stainless Steel Grid
52	1	KK-TS	SearMagic Warming Rack
60	1	GSQCC-36	Gaslow Regulator with Remote Sensor
61	1	HIS	Regulator Hose
<b>GJK-PS ONLY</b>			
57	2	GG-GRID-S	SearMagic Grid (8" wide)
58	1	HH-GRID-S	SearMagic Grid (10" wide)
59	1	KK-TSS	SearMagic Warming Rack
60	1	GSQCC-36	Gaslow Regulator with Remote Sensor
61	1	HIS	Regulator Hose

