



## **Product Information Booklet**

### **Three-Stage Reverse Osmosis System with UV Disinfection**

### **RU300C18 w/UV**

**Booklet includes:**

- Complete Product Category of Reverse Osmosis Systems
- Tearsheet on Individual System with Technical Specifications
- Filter Replacements specific to this unit
- Compliances
- Filter/Filtration Removal and UV Capabilities



### **EWS, INC. and Environmental Water Systems**

### **A Complete Line of Water Filtration Product from Sink to Whole-Home**

**Applicable Water Filtration Available Based on Water Conditions and Consumer Needs and/or Preferences:**

Drinking Water Filtration Systems  
Reverse Osmosis  
UV Disinfection  
CWL Series of Whole Home Filtration Appliances  
EWS Series of Whole Home Filtration & Physical Conditioning  
Softener Series  
pH Balancing  
Iron Removal  
and more...

■ Municipally-Treated   ■ Well Water Applications   ■ Residential   ■ Commercial   ■ Industrial

**ALL FILTRATION PRODUCT MANUFACTURED AND ASSEMBLED IN THE USA**





## Reverse Osmosis Undercounter Filtration Units Three Stage Common Municipal Series

### Model No: RU300C18

Three stage undercounter reverse osmosis system contains a 5-micron pre-sediment filter which removes suspended matter, dirt, rust and sediment to improve performance of other filters. The GAC postfilter removes chlorine and other volatile organic compounds to improve taste, clarity and odor. The CTA membrane removes inorganics, minerals, and total dissolved solids, lead and cysts (giardia and cryptosporidium) and produces up to 18 gallons per day. Unit includes a 3.2 gallon storage tank.

Meets or complies with NSF Standards 42 and 58.

Filter Replacement Codes: 1, 6, 11



### Model No: RU300C18 w/UV

Three stage undercounter reverse osmosis system contains a 5-micron pre-sediment filter which removes suspended matter, dirt, rust and sediment to improve performance of other filters. The GAC postfilter removes chlorine and other volatile organic compounds to improve taste, clarity and odor. The CTA membrane removes inorganics, minerals, and total dissolved solids, lead and cysts (giardia and cryptosporidium) and produces up to 18 gallons per day. Unit includes a 3.2 gallon storage tank. The additional UV module protects against bacterial, viral, E-coli and other microorganisms and is tested 99% effective.

Meets or complies with NSF Standards 42, 58 and 55.

Filter Replacement Codes: 1, 6, 11, 16



Please see notes on RO rejection rates, other device connection issues, information on aggressive water, proper application and more information on these systems in this section of this product manual.

#### All completely assembled reverse osmosis systems include the following standard features:

White 10" housing with filtration cartridges, spanner wrench to open housings for easy filter replacement, easy to use membrane housing, chrome, lead-free faucet with white trim (with air gap adaptor) for dispensing water, self-piercing saddle valve for water line connection with shut-off valve (see service guide for your correct application), all necessary tubing (color coded) to make proper connections, simple to use mounting bracket, UV lamp and setup (UV unit only), pump (booster pump units only), drain saddle and bladder tank, complete service guide with installation and use instructions.

All units are upgraded to produce more water and waste less. All units include a 3.2 gallon storage tank and we incorporate our RSR control valve which monitors flow and operates as a check valve/backflow prevention and an automatic shut-off to protect the system.



## RU300C18w/UV

### Three Stage Undercounter Reverse Osmosis System with UV

#### Model: RU300C18w/UV

Three stage undercounter reverse osmosis system contains a 5-micron pre-sediment filter which removes suspended matter, dirt, rust and sediment to improve performance of other filters. The GAC postfilter removes chlorine and other volatile organics to improve taste, clarity and odor. The CTA membrane removes inorganics, minerals, and total dissolved solids, lead and cysts (giardia and cryptosporidium) and produces up to 18 gallons per day. Unit includes a 3.2 gallon storage tank. The additional UV module protects against bacterial, viral, E-coli and other microorganisms and is tested 99% effective. Meets or complies with NSF Standards 42, 58 and 55.

- \* Faucet with Chrome, Lead-Free Dispenser
- \* Powder Coated, Corrosive Resistant Bracket Mounts Easily
- \* Quick Connect Fittings for Easy Installation
- \* Easy to Use Membrane Housing and 10" Heavy Duty Filter Housings Contain our Full Sized Cartridges for Optimum Performance and Longer Life
- \* Replacing Filters is Easy; Use the Included Spanner Wrench to Spin Housing Off, Replace Filter, Spin Housing Back On



#### Benefits:

- \* Safeguards and Kills Bacteria, Viral, E-Coli and other Microorganisms
- \* Reduces Total Dissolved Solids, Minerals and Inorganics
- \* Reduces Lead and Cysts (Cryptosporidium and Giardia)
- \* Reduces Dirt, Sediment and Rust
- \* Improves Taste, Clarity and Odors
- \* Removes Chlorine and VOC's
- \* Replaces Costly Bottled Water
- \* Better Tasting, Filtered Water for Coffee, Tea, Juices and Ice

#### Applications:

- \* Installs Easily at Any Sink, Wet Bar or Any Point of Use Location
- \* Can be Cross-Connected (if applicable) to Refrigerators, Ice Makers and Other Devices\*\*
- \* For All Your Drinking and Cooking Needs

#### All completely assembled reverse osmosis systems include the following standard features:

White 10" housing with filtration cartridges, spanner wrench to open housings for easy filter replacement, easy to use membrane housing, chrome, lead-free faucet with white trim (with air gap adaptor) for dispensing water, self-piercing saddle valve for water line connection with shut-off valve (see service guide for your correct application), all necessary tubing (color coded) to make proper connections, simple to use mounting bracket, UV lamp and setup (UV unit only), pump (booster pump units only), drain saddle and bladder tank, complete service guide with installation and use instructions.

All units are upgraded to produce more water and waste less. All units include a 3.2 gallon storage tank and we incorporate our RSR control valve which monitors flow and operates as a check valve/backflow prevention and an automatic shut-off to protect the system.

Please see notes on RO rejection rates, \*\*other device connection issues, information on aggressive water, proper application and more information on these systems in this section of the product manual



# RU300C18w/UV

## Technical Information: RU300C18w/UV REPLACEMENT FILTERS

<u>Part No.</u>	<u>Description</u>	<u>Replacement Time*</u>
93023	5 Micron Sediment Cartridge	Up to a Year
CTA-18	18 GPD CTA membrane	Up to 18 months
UDF10HP	10" GAC Cartridge	Up to a Year
UST-200 RL	6 watt UV Replacement Lamp	Annually

### **FILTER SPECIFICATIONS:**

#### **Pre-Filter: 93023**

Construction: 100 % Pure Polypropylene Fibers  
 Temperature Range: 40-145° F (4.4 -62.8C)  
 Maximum Flow Rate: 5 gpm(19 lpm)  
 Dimensions: 2 - 3/8" x4-7/8" (61mm x 124 mm)  
 Micron Rating: 5 µm Nominal  
 Initial Pressure Change: 2.00 psid @1.0 GPM  
 Fits all Standard 10" Housings  
 Meets FDA Requirements for food and beverage contact.

#### **Membrane: CTA-18**

Construction: Cellulose Triacetate  
 Temperature Range: 40° to 85°F (4.4° to 29.5° C)  
 Maximum Flow Rate: 1 gpm(3.875 lpm)  
 Dimensions: 1.75" x 11 3/4" (44.5 X 298.5 mm)  
 TDS Rejection : 90 - 98%  
 Test Feed Conditions: 500 PPM  
 San Diego Tap @65 PSI and 77°F.  
 Maximum Feed Turbidity: 1 NTU  
 Maximum Pressure: 125 PSI  
 Chlorine Residual: 2.0 PPM Max. / 0.2 PPM Min.  
 All Materials meet FDA requirements and meets or complies with NSF Standard 58.

#### **Post Filter: UDF10HP**

Vibration Packed Granular Activated Carbon  
 Carbon Wt.: 0.75 lbs. Iodine Rating No. 1100  
 Temperature Range: 40° to 125°F (4.4° to 52°C)  
 Maximum Flow Rate: 1 gpm (3.875 lpm)  
 Dimensions: 2- 7/8" x 9 3/4" (73 X 248 mm)  
 Micron Rating: 5 µm Nominal  
 Initial Pressure Change: 2.00 psid @1.0 GPM  
 Chlorine Reduction: 2,500 Gal. @ 1.0 GPM  
 Fits all Standard 10" Housings  
 Cartridge is Tested and Certified by International  
 ANSI/NSF Standard 42 - Conforms to requirements.

#### **Ultraviolet Lamp: UST-200 RL**

Construction: 316 Bonded Stainless Steel Interior  
 Temperature Range: 40-105° F (4.4 - 40°C)  
 Maximum Flow Rate: 1.0 gpm (3.875 lpm)  
 Dimensions: 2 in. O.D. x 11.50 in. L (51 mm x 292 mm)  
 U.V Rating Output: 30,000 micro-watts at maximum flow  
 Watts: 6 Ports: 1/4 in.  
 UV Module meets or complies with NSF Standard 55.  
 All materials meet FDA or NSF requirements. The UV unit was effective in killing (> 99%) E-coli and significantly reducing the level of micrococcus luteus.

Tubing Size: 1/4 in. O.D.  
 System Weight: 27 lbs. 12.3 Kgs.  
 System Size: 17"W x 16"L x 17"H  
 43 cm x 41 cm x 43 cm  
 Min/Max Water Temperature: 40° / 80 °F - 4.4 / 62.8C  
 Max Water Pressure: 75 PSI / 5.86 Bar  
 Housing Inlet / Outlet Size: 1/4 in. O.D. tube female  
 Quick Connect x 1/4 in. MNPT  
 Flow Rate : <1.0GPM / 3.78 LPM

#### **SHIPPING INFORMATION**

Carton Size.:17"W x 16"L x 17"H  
 Carton Wt.:27 lbs. / 12.3 Kgs.

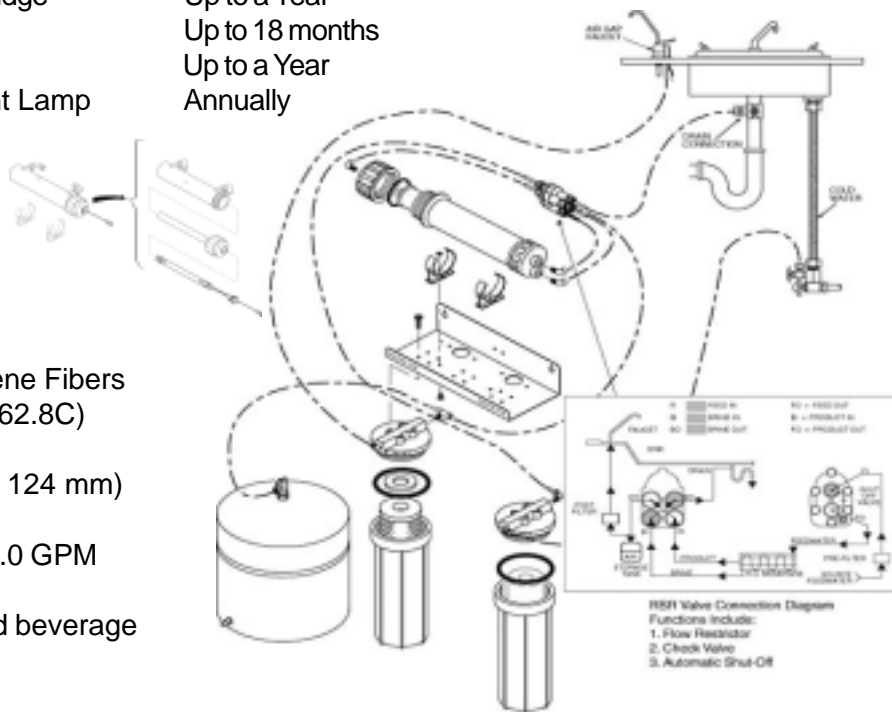



## Filter Cartridge Replacements for RU300C18 w/UV

**Filter Code No: 1**  
**Model No: 93023**

**Replace: up to a year\***



### **Pre-Sediment Filter (5-micron)**

5-Micron Prefilter (93023) is a pure, high quality polypropylene depth filter, with no fillers or binders, with exceptional dirt holding capability. The removal of any dirt, silt, rust or suspended matter protects the remaining cartridges and extends the performance of other filters. This Prefilter is standard in all our undercounter drinking water systems and reverse osmosis units.

Meets or complies with all FDA requirements for food and beverage contact.

**In Use With: All Units**

**Filter Code No: 6**  
**Model No: UDF10HP**

**Replace: up to a year\***

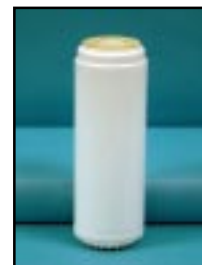

### **Granular Activated Carbon (GAC) Postfilter++**

This vibration packed cartridge uses the highest quality (Iodine No. 1100) granular activated carbon for effective reduction of taste, clarity and odor problems such as Chlorine and VOC's. Cartridges are designed to allow water to pass through entire carbon bed to allow maximum adsorption. This Postfilter is standard in our; FUGAC100, FUGAC200, FUGAC300 and all Reverse Osmosis Units.

Meets or complies with NSF Standard 42. See Removal Reference Chart.

**In Use With: All reverse osmosis units**

++Compare to loosely filled cartridges using carbon of lower Iodine No's. (industry standards are 600-650, imported filters may meet minimum compliances at 450). Be cautious of impregnated papers, KDF media and/or combined materials and filter purposes. Be aware of smaller filter diameters and limited time, usage and replacement requirements.

- **For alternative filtration capabilities, or more appropriate application see our Drinking Water Systems, the Best (UU250), or, if applicable on well water, our Four or Five-Stage selection of Reverse Osmosis Systems.**
- **For filtration to the whole home see our CWL or EWS Series of whole home filtration appliances.**

**\*Replacement is based on local water conditions and usage.  
Replace as needed and/or not beyond recommended time limit**



## Membrane and UV Lamp Replacements for RU300C18 w/UV

**Filter Code No: 11**

**Model No: CTA-RO**

**Replace: up to 18 months\***

### **CTA Membranes - Reverse Osmosis Systems**

CTA membrane (CTA-18) removes Total Dissolved Solids to improve the taste and quality of water. Tap water is forced by pressure through a semi-permeable membrane while dissolved solids and particulates are left behind. The CTA membrane is chlorine tolerant and is used correctly on municipally treated water or treated well water. Available on all our reverse osmosis units with a C18 code in the model number. Meets or complies with NSF Standard 58. See Rejection Rates.

**In Use With: RU300C18, RU300C18w/UV**



**Filter Code No: 16**

**Model No: UST-200 RL (lamp only)**

**Replace: Annually, or as needed\***

### **UV Lamp - UV Bacteria-Kill Units**

UV Unit (UST-200) is a 6 Watt UV lamp that effectively kills bacteria (>99%). 316 Bonded Stainless Steel Interior enhances kill power by reflecting UV light and eliminates degradation of polypropylene housing. Due to advanced design, water is spun through the module to eliminate shadowing and shading which additionally maximizes kill power. Made in USA. Lamp Life: To be replaced after 1 year of continuous operation. UV Module meets or complies with NSF Standard 55. See Testing.

**In Use With: UU250, UU350, All reverse osmosis with UV upgrade**



- **For alternative filtration capabilities, or more appropriate application see our Drinking Water Systems, the Best (UU250), or, if applicable on well water, our Four or Five-Stage selection of Reverse Osmosis Systems.**
- **For filtration to the whole home see our CWL or EWS Series of whole home filtration appliances.**

**\*Replacement is based on local water conditions and usage.  
Replace as needed and/or not beyond recommended time limit**



## FDA, EPA and NSF Compliances

Please be advised that all the materials and components utilized in producing all POU (Point of Use) drinking water filtration and reverse osmosis systems, and all POE (Point of Entry) filtration, conditioning and softening equipment, by EWS, Inc., comply with, but are not limited to, one or more of the following regulating standards:

NSF STANDARD 14	FDA 21 CFR 177.1520	FDA 21CFR 177.1640
FDA 21 CFR 177.1350	FDA 21 CFR 175.105	CAS # 7440-44-0
ANSI 304	CDA C360000	NSF STANDARD 60
NSF STANDARD 61	NSF STANDARD 58	ANSI 302
ANSI 316	FDA 21 CFR 177.2600	FDA 21 CFR 175.300
FDA 21 CFR 177.2550	NSF STANDARD 52	NSF STANDARD 42
NSF STANDARD 18	FDA 21 CFR 177.2550	FDA 21 CFR 177.1655
FDA 21 CFR 177.1630	FDA 21 CFR 177.2800	FDA 21 CFR 175.300
FDA 21 CFR 177.2260	FDA 21 CFR 181.32	FDA 21 CFR 177.2660
FDA 21 CFR 177.1950	FDA 21 CFR 177.2910	FDA 21 CFR 177.2250
FDA 21 CFR 177.1680	NSF STANDARD 53	NSF STANDARD 55

- Most of these standards relate to the Code of Federal Regulations of the United States of America, Title 21, Charter 1, Subchapter B set forth by the U.S. Food and Drug Administration.
- The NSF (National Sanitation Foundation) standards correlate to materials and potable water.

Furthermore, and without, exception every component included in all POU and POE systems by EWS, Inc. are compliant for food and beverage contact and/or meet or comply with the most current, appropriate, and applicable standards without exception.

### Factory Preparation Summary:

All systems are factory prepared and thoroughly checked to assure proper function and if applicable, quality tests of product water produced to assure that minimum standards of rejection have been met, and/or tests of specific components to assure correct function and flow rate measurements to assure efficiency specifications are met.

### Product Performance Summary: Detailed in Section 5, pg. 5-34

- ◆ For all product capabilities, compliances and/or warranties to remain valid, all systems are dependent upon proper application, specification, and installation of any specific unit and/or combination of units.
- ◆ Please know your local or individual water condition(s), and plumbing application(s). Please review system(s) capabilities, applications, setup, installation, startup, maintenance, and related warranties.
- ◆ Detailed information is published in EWS Product Manuals and specific Product Service Guides (included with each specific unit) and made available upon request throughout US distribution and/or EWS corporate offices. All current information is available online @ [www.ewswater.com](http://www.ewswater.com) or [www.ewswater.com/techandspec.html](http://www.ewswater.com/techandspec.html)

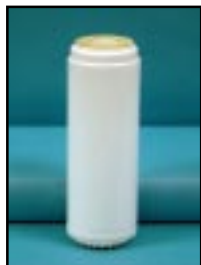

### UDF10HP GAC Filter Cartridge

Filter cartridge UDF10HP meets or complies with NSF Standard 42 for reduction of Chlorine and other Volatile Organic Compounds. The UDF10HP utilizes a vibration packed, high performance granular activated carbon (Iodine No. 1100) which provides exceptional filtration capacity and effectively reduces chlorine, voc's, bad taste and odor in drinking water.

In use with: all Reverse Osmosis Units.

### GRANULAR ACTIVATED CARBON (GAC) Reference List

Below is a simple reference chart to give some perspective as to GAC's capabilities with various substances. Some items are heavy metals and inorganics, while others are VOC's (volatile organic compounds), some of which are man-made pollutants. Still other items, such as hardness, are not even considered contaminants. In general, GAC is very economical and a great compliment to municipally-treated water without the disadvantages of more aggressive filtration. GAC is used in all filtration due to its removal capacities. Know your water to select the correct product for you, your family and your home.

- UV disinfection for greater safeguards (UU250, UU350, optional with Reverse Osmosis)
- See CWL or EWS whole home appliances for GAC filtration to the entire home.

**All Reverse Osmosis Systems require carbon filtration for taste, odor, chlorine, and VOC's (see #'s 3, 4 & 5 on list below)**

Acetaldehyde	4	Emulsions	2	Lead	3	Precipitated Sulfur	2
Acetic Acid	3	Ethyl Acetate	5	Lime	0	Propioic Acid	4
Acetone	4	Ethyl Acrylate	5	Mercaptans	4	Propionaldehyde	3
Alcohols	4	Ethyl Alcohol	4	Metal Salts	1	Propyl Acetate	4
Alkalinity	1	Ethyl Amine	4	Methyl Acetate	4	Propyl Alcohol	4
Amines	3	Ethyl Chloride	4	Methyl Alcohol	4	Propyl Chloride	4
Ammonia	1	Ethyl Ether	4	Methyl Bromide	5	Radon	4
Amyl Acetate	5	Fertilizers	1	Methyl Chloride	4	Rubber Hose Taste	5
Amyl Alcohol	5	Fluorides	2	Methyl Ethyl Ketone	5	Seawater	1
Antifreeze	4	Formaldehyde	2	Naphtha	5	Sediment	2
Arsenic	1	Gasoline	5	Nitrates	0	Soap	3
Benzene	5	Glycols	5	Nitric Acid	3	Sodium Hypochlorite	5
Bleach	5	Hardness	0	Nitrobenzene	5	Soluble Iron	2
Boron	1	Heavy Metals	3	Nitrotoluene	5	Solvents	4
Butly Alcohol	5	Herbicides	5	Odors (General)	5	Sulfuric Acid	1
Butly Acetate	5	Hydrogen Bromide	2	Oil - Dissolved	5	Sulphonated Oils	4
Calcium Hypochlorite	5	Hydrogen Chloride	1	Oil - Suspended	2	Suspended Matter	2
Carbon Dioxide	0	Hydrogen Fluoride	1	Organic Acids	4	Tannins	4
Chloral	5	Hydrogen Iodide	2	Organic Esters	5	Tar Emulsion	4
Chloramine	4	Hydrogen Peroxide	5	Organic Salts	4	Tartaric Acid	4
Chloroform	5	Hydrogen Selenide	3	Oxalic Acid	5	Taste (DI Water)	4
Chlorine	5	Hydrogen Sulfide	3	Oxygen	5	Taste (From Organics)	4
Clorobenzene	5	Hydrochlorous Acid	5	Ozone	4	THM's	5
Chlorophenol	5	Inorganic Acids	1	PCB's	5	Toluene	5
Chlorophyll	4	Inorganic Chemicals <sup>1</sup>	1	Pesticides	5	Toluidine	5
Citric Acid	4	Insecticides	5	Phenol	5	Trichlorethylene	5
Cresol	5	Iodine	5	Phosphates	0	Turpentine	5
Defoliants	5	Isopropyl Acetate	5	Plastic Taste	5	Urine	2
Detergents	3	Isopropyl Alcohol	5	Plating Wastes	3	Vinegar	3
Diesel Fuel	5	Ketones	5	Potassium Permanganate	4	Xanthophyll	4
Dyes	5	Lactic Acid	4	Precipitated Iron	2	Xylene	5

#### KEY TO THE ABOVE LIST:

5- EXCELLENT - A proven application      4- VERY GOOD - A proven application      3- GOOD - very acceptable result  
 2- FAIR - limited application      1- POOR - not a recommended application      0- Not an application for GAC



### UST-200 RL and the UV Module

The addition of a UV module provides for the safeguard against Bacteria, E-coli, Viral and other Microorganisms and Meets or complies with NSF Standard 55.

In use with: UU250, UU350 and optional, as an upgrade, with Reverse Osmosis units

- Lamp Information: Life up to, or better, 1 year of continuous operation;  
Replace annually  
Testing information below
- Housing: 2"O.D. x 11.50" L;
- Bulb Wattage: 6 Watts
- UV Output: 30,000 micro-watts at maximum flow rate
- Inlet Water Temperature: 40-105° F
- Maximum Flow Rate: 85 PSI
- Maximum Static Temperature Rise: 16.1° F above ambient\*

\* Water will be warm when sitting. Simply, run water until cool.

- \* Lower Housing contains a 316 bonded stainless steel interior for better UV contact which maximizes killing power by reflecting UV light and the off-centered in/out, side ports allow water to spin through module to eliminate any shadowing or shading during UV contact.
- \* Upper Housing Cap seals module and contains opening and easy-to-clean quartz sleeve where UV lamp is inserted.
- \* UV Lamp (UST-200 RL) and electrical step-down transformer, both with snap-fit cap for easy lamp removal.
- \* Sight port allows consumer to see whether UV lamp is on.



UV Results: "The unit was effective in killing E-coli and significantly reducing the level of micrococcus luteus. Based on previous testing, the unit produces aproximately 17,000 μwatt/seconds when operated at a low rate of 0.75 gallons per minute." TRUESDAIL LABORATORIES, INC., TUSTIN, CA, U.S.A. 1989 LABORATORY NO. 26995.

Organism Tested	Control Count	Exposed Count	Percent Reduction of Control
E-Coli	1,400,000	<1*	>99.99992
Micrococcus Luteus	500,000	1170	99.66
Micrococcus Luteus	500,000	850	99.83

The unit was tested by pumping bottled spring water seeded with E-coli (ATCC 8739) and Micrococcus luteus (ATCC 9341) through at a rate of 0.75 gallons per minute. The unit was allowed to warm up five minutes before testing. Samples of the exposed and non exposed water were taken and duplicate plate counts conducted (plate Count Agar, 35C, 48 hours). The results are given above.:

The UV lamp is effective through one year of continuous service and must be replaced annually to maintain a 99% effective rate.



## RO Rejection Rates

### APPROXIMATE RO REJECTION RATES OF VARIOUS IMPURITIES\*

Aluminum	up to 98%	Manganese	up to 98%	Barium	up to 92%	Mercury	up to 97%
Bicarbonate	up to 98%	Nitrate	up to 95%	Bromide	up to 96%	Organic Pesticides	up to 98%
Cadmium	up to 98%	Phosphate	up to 98%	Calcium	up to 98%	Polyphosphate	up to 98%
Chloride	up to 98%	Potassium	up to 98%	Magnesium	up to 97%	Copper	up to 98%
Radium	up to 98%	Cyanide	up to 96%	Silica	up to 98%	Detergents	up to 98%
Silicate	up to 98%	Fluoride	up to 98%	Sodium	up to 96%	Iron	up to 98%
Sulfate	up to 98%	Radioactivity	up to 97%	Orthophosphate	up to 98%	Boron	up to 70%
Ammonium	up to 90%	Nickel	up to 98%	Strontium	up to 97%	Silver	up to 96%
Chromium	up to 96%	Chromate	up to 95%	Sulphite	up to 96%	Thiosulfate	up to 98%
Ferrocyanide	up to 98%	Borate	up to 50%	Selenium	up to 95%	Lead	up to 98%
Zinc	up to 98%	Arsenic	up to 95%				

\* Operational, maintenance, and replacement requirements are essential for the product to perform as advertised. Rejection rates may vary slightly between CTA & TFC membranes. Rates based on the following test feed water: Temperature: 77°F (25°C) TDS: 500 ppm. Pressure: 60 PSI. Membranes meet or comply with NSF Standard 58.

*This is partial list or sample of impurities. New items are added based on developing protocols and standards.*

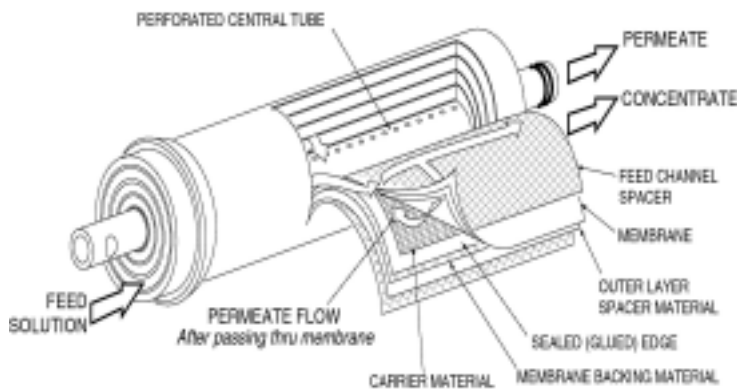

**CTA (Cellulose Triacetate):** CTA membrane may be used for chlorinated and non-chlorinated water supplies. Product water produced = 5 - 20 gallons per day.

**TFC (Thin Film Composite):** TFC membrane is a long-life membrane for non-chlorinated water supplies. A carbon filter must precede the RO element if used on chlorinated feedwater. Product water produced = 10 - 50 gallons per day.

#### Performance Parameters

	TFC	CTA
Daily Production Rate (To Atmosphere at 4.25 Kg/Sq. cm: 60 PSI: 25° C / 77° F: 500 mg/l. TDS)	up to 35 GPD	up to 18 GPD
Average TDS Rejection	94-98%	94-98%
<b>Feed Water Chlorine Tolerance</b>	<b>No</b> unless carbon prefilter	<b>Yes</b>
Feed Water Temperature	5-30° C/40-90° F	5-30° C/40-90° F
Feed Water pH	3.0 - 11.0	4.0- 9.0
Feed Water Pressure*	3-6 Kg/Sq cm/40-75 PSI	3-6 Kg/Sq cm/40-75 PSI
Maximum TDS	2000 mg./l	1500 mg./l
Maximum Hardness**	350 mg./l	350 mg./l
Maximum Iron Feed Water	0.1 mg./l	0.1 mg./l
Maximum Manganese Feed Water	0.05 mg./l	0.05 mg./l
Free Chlorine Feed Water	< 1.5 mg./l	< 1.5 mg./l
System Recovery Rate	20% @ 4.25 Kg./Sq. cm.	20% @ 4.25 Kg./Sq. cm.

Notes: \*see Booster Pump option, \*\*20.5 grains per gallon

#### See the next pages:

- Determine whether reverse osmosis is right for your needs or application.
- Learn why we provide the finest quality reverse osmosis systems with our RSR Control Valve
- Determine what reverse osmosis system you need for your application
- Determine whether or not you may need a booster pump option (RU500T35 series only)



## RO Information

### REVERSE OSMOSIS - Is it right for you?

Reverse Osmosis or "RO" has become a term that has slipped into our common language. When you need a tissue and ask for a "Kleenex", its not the brand you need, it's the tissue. It's the same with RO. You may ask for the device, be told you need one, or be considering buying one without understanding what you're asking for. Unlike the tissue however, this decision can be impactful.

**How does an RO work?**

Water is forced by pressure through a semi-permeable membrane while dissolved solids and particulate matters are left behind. The residual contaminants are flushed to the drain. The resulting product water is a cleaner, safer water. These residential units are point of use or sink applications. Asking to do the whole house does not take into account; storing the production water and other drawbacks to the installation and operation of an RO system. Commercial or industrial RO systems can be very complicated, expensive and are designed for specific needs and applications.

**Any drawbacks to an RO unit?**

The drawbacks are why EWS, Inc. provides the consumer a selection of product and why we include this information to help you decide what product is right for you. Here are only a few things to consider.

- RO's can waste up to 20 gallons of water for one produced (our ratio is a low 3-6 gallons per 1).
- RO's produce very aggressive water. You can not plumb the filtered water in copper (the water will eat away or leach the copper) and, if cross-connected to other sources such as an ice-maker, it may provide warranty or service issues. When bottled water is produced, one of the methods to produce that water is reverse osmosis, however essential minerals are added back "for a pure, fresh taste" as quoted on any label of Dasani, a bottled water produced throughout the USA by Coca Cola. Please note - all spring waters, bottled at the source, have natural minerals and total dissolved solids of varying degrees, which provide the consumer a choice based on taste. (see Evian, Panna, Pellegrino, etc...)
- If an RO system is working correctly, the water can taste flat (like distilled) or metallic. The water produced may be wet, however your plants may not like it. The water is aggressive, it flushes, and does not allow for assimilation starving the plant which may be a drawback for you as well.

**When is an RO appropriate to use?**

See the page on rejection rates and all those scary things. If you're on municipal water, call your utility and request a recent report. Those items on that list are highly regulated. They are either not in your water or municipally treated, and therefore RO can be redundant and unnecessary. If you're on well water, have your water completely and independently tested. Do not trust a local salesman. He's the guy who's usually pushing RO along with the softener, so the RO can take the salt out of the water that the softener put in!

**An interesting note:**

RO will not remove chlorine and other volatile organic contaminants without the carbon filter(s) in one or more of the stages. If your on municipally-treated water without issues applicable for an RO unit, select a drinking water system or whole home appliance to compliment your utilities' water for taste, odor, clarity, chlorine, VOC's, lead, cysts and microorganisms.

**Are you looking for better tasting water?**

This may be the best place to start and finish. The RO unit would not take out taste and odor, the Chlorine and VOC's if not for the Carbon (GAC) filter. Maybe you simply need a basic drinking water system (FUGAC200) or to upgrade to Lead and Cysts removal, the RO is fine, but so is a 1-micron carbon block cartridge found in our FUGAC250. Bacterial safeguard? Add our UV option to your RO unit or see the complete UU250 as an alternative.

- Removal of fluoride?    Yes, remove                      you'll need an RO or weigh your options;  
   No, do not remove              use any of the drinking water system options, as mentioned above.

■ **The Bottom Line**

RO's have become popular without good information. Door-to-door salesmen sell the system to remove the salt from the water that the softener they want to sell you, puts in. Most RO's sold in big box programs, that have a attractive cheap price, are poor systems and provide questionable filtration (especially, if you need an RO) and varied maintenance issues. Drinking water systems take up less room (RO's have the storage bottle), make as much water as you like (RO's have limited production) are easier to install and maintain, can be cross-connected without issues, have less hassles, and are less costly (RO's have drain connections, need an air gap by some codes, and make noise during production). However, if an RO is required based on your taste, needs, concerns and/or local water conditions at least you made an informed decision and have been provided a complete selection of RO product for proper application.



## The Needed Option and Correct Application of Booster Pumps

Booster pumps are critical to the effective performance of reverse osmosis membranes in low water pressure situations (feedwater below 40 PSI and/or high TDS). Along with mechanical and electro-mechanical options, booster pumps enhance RO systems in the following ways and are available in our 5 Stage Series, the RU500T35 w/BP or the RU500T35 w/BP w/UV (with our UV disinfection option):

- Monitoring performance
- Improving membrane efficiency
- Conserving water
- Conserving power
- Shutting down the pump when continuous product water is not necessary

Booster pumps P6000 are recommended in reverse osmosis applications where feedwater pressure is less than 40 PSI. Feedwater high in Total Dissolved Solids (TDS) may need a boost, in order to perform within rejection parameters.

**FACT:**

Over 500 mg/l or ppm TDS, the PSI will be reduced by 1 PSI for every 100 TDS.

**Example:**

Feedwater that is 2,000 mg/l of TDS will reduce PSI by 15. A booster pump will compensate to allow for proper application. On well-water, know your water pressure (PSI) and your TDS (total dissolved solids).

Available only in the 5 Stage Series of Reverse Osmosis Systems, with or without, UV Disinfection option.

### All EWS Reverse Osmosis Systems contain our RSR Control Valve The "All in One" Control Valve

The RSR Valve includes the Flow Restrictor, Check Valve and Automatic Shut-Off Valve for optimum performance. The RSR-100 (CTA membrane) and RSR-150 (TFC membrane) are unique because they utilize a calibrated, stainless steel orifice to regulate the waste flow. The jet-stream force of the water going through the orifice will not allow scale to form. Therefore, the flow rate across the membrane is constant, enabling it to function at its optimum level. As a result, the life of the membrane will be extended as well.

Better performance, less maintenance,  
less wasted water

A product not subject to the typical leaking  
of the other manufacturers' units.

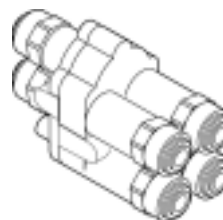



## Chiller KMA-200-C

**EWS presents the option of chilled water with any of our undercounter water filtration systems or our selection of whole home water filtration appliances**

EWS Model Number: KMA-200-C

### The Perfect Residential In-Line Water Chiller.

- Delivers over two gallons of cold water per day.
- Advanced and Proven Thermoelectric Technology, used throughout Europe. No old and inefficient compressors.
- Compatible with all EWS residential drinking water and reverse osmosis systems, and all CWL/EWS whole home appliances.
- Compact size & easy undercounter installation.
- Quiet, efficient & reliable.
- Operates under normal household pressure.



### Cold Water at Your Fingertips!

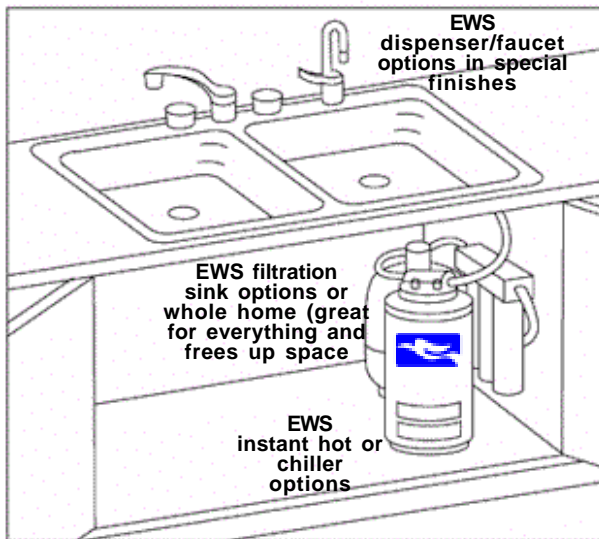

**Dimensions:** 8" diameter x 18.5" height **Weight:** 12 lbs.  
**Maximum Water Pressure:** 60 psi  
**Electrical:** Separate UL listed 120 vac or CE marked 240 vac Power Converter. Chiller operates on 12 vdc and 4 amps.  
**Compliance:** All waterways are constructed of NSF and/or FDA compliant materials.

### Why Chilled Water?

- Eliminates the need for dispensing water in the refrigerator/freezer, which can be costly and takes up valuable freezer shelf and door space.
- Puts the chilled water at the sink for easy usage. Fill any size cup or bottle with cold filtered water.
- Avoids the spills of dispensed refrigerator water. No more mess at the drain and on the floor.
- A perfect compliment for those consumers purchasing separate stand alone ice-makers.

### To buy an instant hot or chiller ?

EWS can provide you both and with all your water filtration options. Microwaves provide hot water very quickly for most usages without storing stale water.\*\*\*

Chilled water is wonderful for drinking, used more frequently, and may be a more preferred option.

\*\*\* EWS has heaters available, however the pricing of other companies and big box retailers have stifled any opportunity to create a better unit. They just dress them up. Heaters are prone to failure and a consumer nightmare when they leak. Heaters are unnecessary anyway - instant coffee anyone?



## Point of Use (sink) Pressure Limiting Valve Highly Recommended

- This device is of vital importance to reduce pressure or prevent pressure surges above 60psi.
- All heaters and chillers have warranty issues with water supply pressure exceeding 60psi.
- All Point of Use (sink) Product function best above 40psi but should be limited to 60psi for optimum performance and product longevity.

Item #: FMP-60

**High pressure system to protect drink dispensers,  
water filters, ice makers, coffee machines,  
chillers (cold water systems),  
hot tanks (hot water systems) and other devices**

Easy to install at supply side to any device  
Simple connection with supplied quick connect  
fittings to 1/4" tubing

- Integral Dual Check Valves • Resists Water Hammer
- Stops backflow • Supplied with fixing clip



**This device is highly recommended with the use of  
all Chillers, Heaters, In-Lines,  
and all other Point of Use filtration systems**

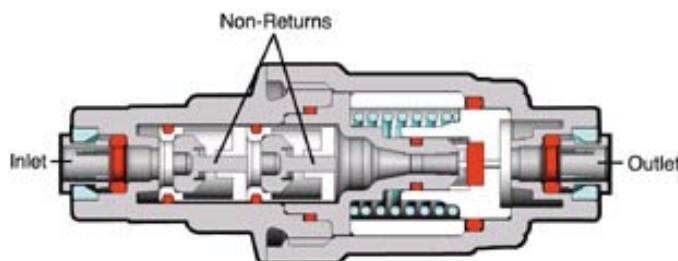



### Dispenser Finish Options

All Drinking Water Systems and Reverse Osmosis Systems include: Standard long-reach dispensers  
Chrome with white tip and handle trim (air gap adaptor included - RO unit only)

### To Order with Any Unit as an Upgraded Dispenser

Select Finish Option	Upgrade and Order Complete with any EWS Point of Use (sink) Filtration System <i>ADD the Finish Code to the EWS Model # (ie: RU300C18 - SN)</i>
PVD Satin Nickel	xxxx - SN
PVD Polished Nickel	xxxx - PN
PVD Polished Brass	xxxx - PB
PVD Oil Rubbed Bronze	xxxx - ORB

All PVD Finish Options come with black trim



### Important:

Water filtration is not an add-on, gimmick or accessory.

It is a primary consideration for you and your family.

Once you have selected a sink filtration system, then select the dispenser you would like to see the water coming from.



## EWS, Inc. / Environmental Water Systems

The complete EWS, Inc./Environmental Water System product line from sink to whole-home, available through:

Available on the Internet through Authorized Retail Web Distributors  
[www.waterontheweb.com](http://www.waterontheweb.com)  
and  
Business-to-Business E-Commerce Distributors.

Available through Authorized Building Wholesale Supply Locations, Kitchen & Bath Showrooms and Appliance Dealers, and their Building and Plumbing Contractors throughout the United States.



### **EWS, INC. and Environmental Water Systems A Complete Line of Water Filtration Product from Sink to Whole-Home**

**Telephone:** 702-256-8182  
M-F, 8:30am - 4:30pm  
Pacific Standard Time

**Fax:** 702-256-3744

**E-Mail:** [customerservice@ewswater.com](mailto:customerservice@ewswater.com)

**Web Site:** [www.ewswater.com](http://www.ewswater.com)

For all product information, service guides, technical specifications, well water applications, go to: [www.ewswater.com/techandspec.html](http://www.ewswater.com/techandspec.html)

**ALL FILTRATION PRODUCT MANUFACTURED AND ASSEMBLED IN THE USA**

