



BARREL TOP TOY CHEST

PRODUCT MODEL NUMBERS:

01330 - Natural

01335 - White

01340 - Cherry

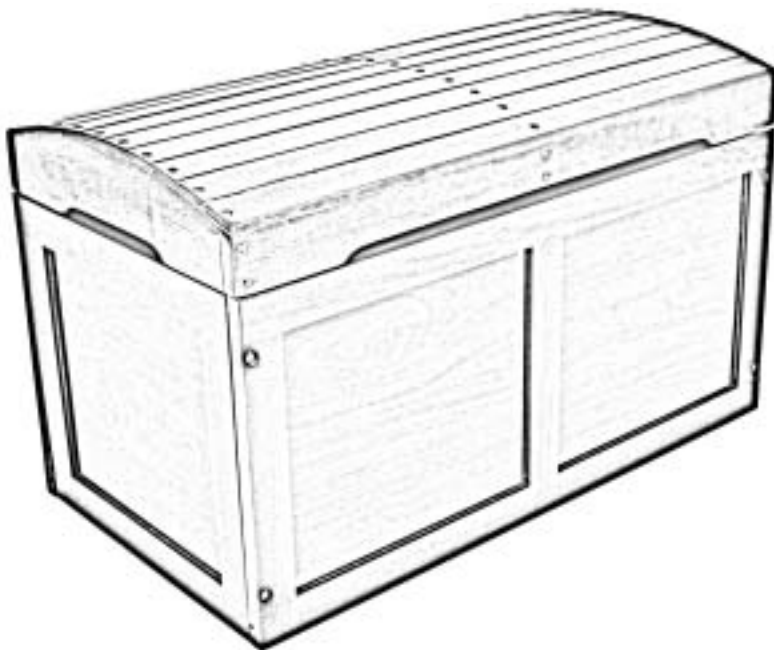

**Assembly
Instructions.**

**Adult Assembly
Required.**

**Save these
instructions for
future use.**

Visit us online at www.badgerbasket.com

Toll-Free Customer Service: 1-800-236-1310 (Monday to Thursday 7:30 AM-4:30 PM CST)

Web: <http://www.badgerbasket.com/parts> • **E-mail:** parts1@badgerbasket.com

PLANT AND GENERAL OFFICE: PO Box 227, Edgar, WI 54426-0227 • Phone: 715-352-2311 • Fax: 715-352-3163

CORPORATE OFFICE: 111 Lions Dr., Suite 220, Barrington, IL 60010

PARTS AND HARDWARE:



BEFORE YOU BEGIN ASSEMBLY:

Check all parts and hardware listed. If anything is missing, please **DO NOT** call the store or return the product to them. Contact us for assistance. Most problems are resolved without you needing to leave home. When emailing or calling us, please have this instruction manual and your product model number ready. For fastest service, go to <http://www.badgerbasket.com/parts>

TOOLS NEEDED:

Phillips Screwdriver

Power screwdriver is helpful, but be careful not to damage the product.

PARTS INCLUDED:

- (A) 1 - Rear Panel
- (B) 1 - Right Side Panel*
- (C) 8 - Bolts
- (D) 8 - Barrel Nuts
- (E) 1 - Support Bar
- (F) 1 - Front Panel
- (G) 1 - Bottom Panel
- (H) 1 - Left Side Panel*
- (I) 1 - Barrel Top Lid
- (J) 2 - Hinges
- (K1) 8 - Long Screws
- (K2) 4 - Short Screws
- (L) 1 - Safety Hinge Lid Support

** side panels are identical and interchangeable*



WARNING !!

NO CHILD OR ADULT should ever attempt to sit or stand on the Toy Box. It is not designed to be used as a seat, step stool, or ladder. You may damage the product and cause personal injury if you attempt to sit, stand, or climb on it.

HARDWARE DIAGRAM:

(not to scale)

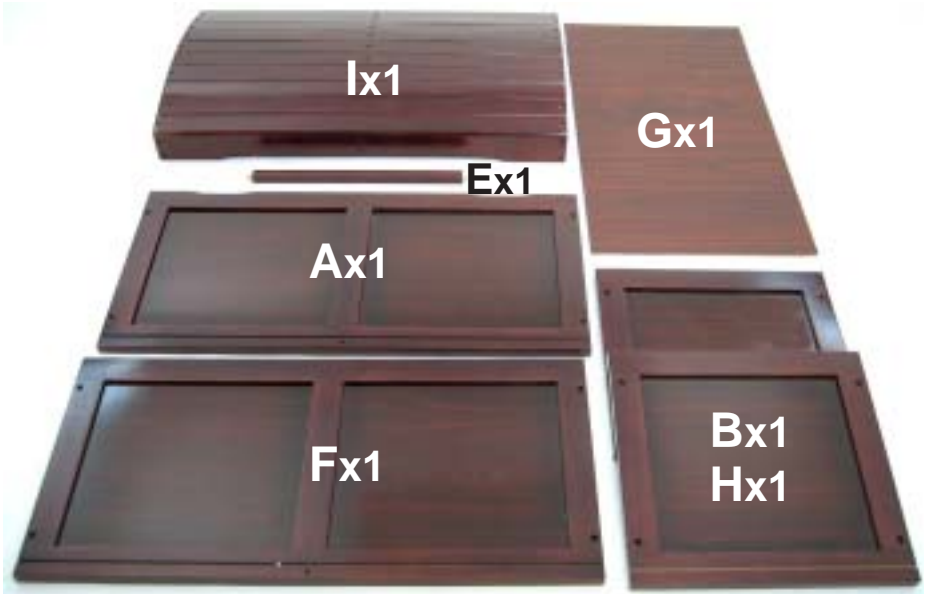
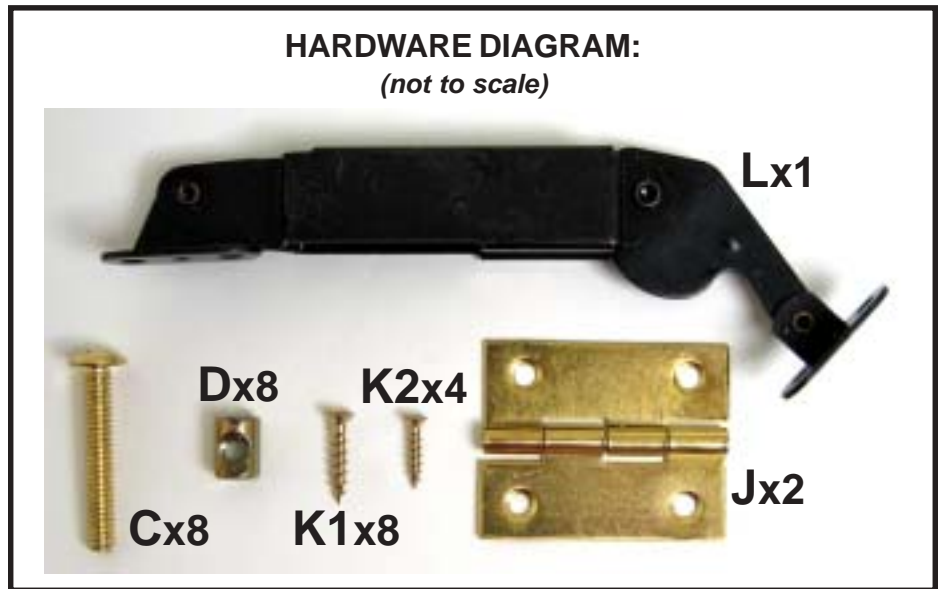

STEP 1: See PICTURE 1. Attach the REAR PANEL (A) to the RIGHT SIDE PANEL (B) using TWO BOLTS (C) and TWO BARREL NUTS (D). Insert the barrel nuts into the holes on the side panel; then insert the bolts through the holes on the rear panel and screw them into the barrel nuts.

The bottom grooves on the panels face in and line up with each other. Insert the wood peg on the end of the SUPPORT BAR (E) into the hole in the center of the REAR PANEL (A).

STEP 2: See PICTURE 2. Attach the FRONT PANEL (F) to the RIGHT SIDE PANEL (B) using TWO BOLTS (C) and TWO BARREL NUTS (D).

The bottom grooves on the panels face in and line up with each other. Insert the wood peg on the end of the SUPPORT BAR (E) into the hole in the center of the FRONT PANEL (F).

PICTURE 1

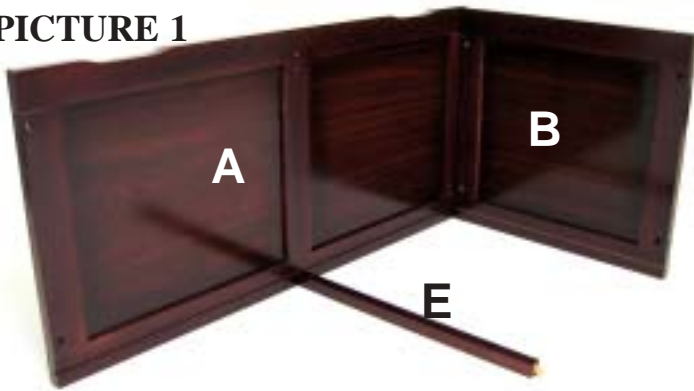

PICTURE 2

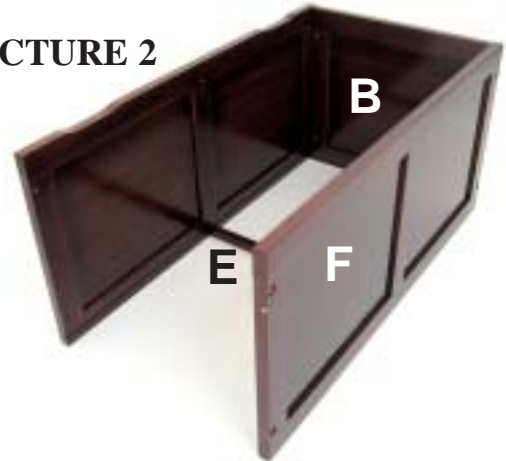

STEP 3: See PICTURE 3. Slide the BOTTOM PANEL (G) into the grooves on the REAR PANEL (A), RIGHT SIDE PANEL (B), and FRONT PANEL (F). Be sure the bottom panel is properly seated into the grooves on all three sides. The wood grain side faces up.

STEP 4: See PICTURE 4. Attach the LEFT SIDE PANEL (H) to the REAR PANEL (A) and the FRONT PANEL (F) using FOUR BOLTS (C) and FOUR BARREL NUTS (D). Be sure the BOTTOM PANEL (G) is seated into the groove on the LEFT SIDE PANEL (H).

PICTURE 3



PICTURE 4

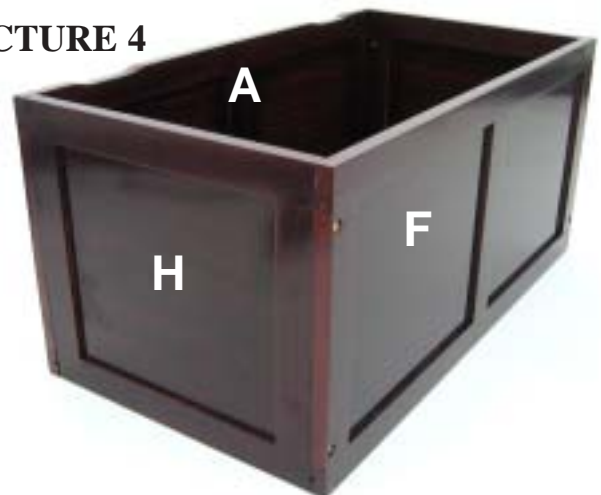

STEP 5: See PICTURES 5A and 5B. Attach the BARREL TOP LID (I) to the REAR PANEL (A) using the TWO HINGES (J), EIGHT LONG SCREWS (K1), and the pre-drilled holes on the lid and rear panel.

If you don't have an assistant to hold the lid while you turn the screws, you can do this step alone if you rest the toy box on its back as shown in PICTURE 5A.

PICTURE 5A

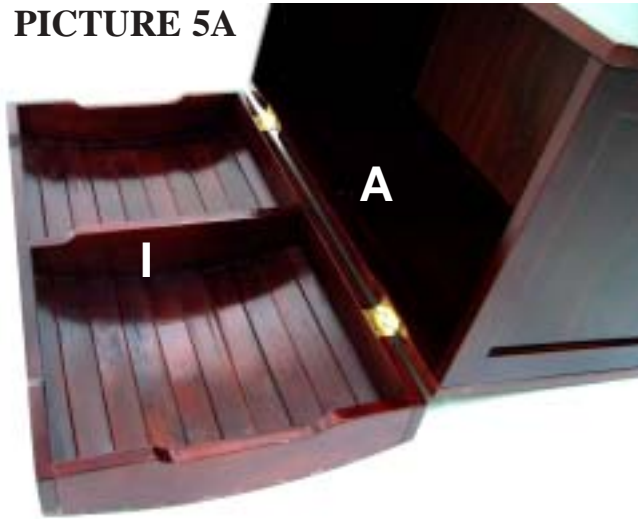

PICTURE 5B - close-up view of Hinge & Screws



STEP 6: See PICTURE 6. Properly position the SAFETY HINGE LID SUPPORT (L) and attach it to the BARREL TOP LID (I) and REAR PANEL (A) using FOUR SHORT SCREWS (K2) and the pre-drilled holes on the lid and rear panel. **YOUR BARREL TOP TOY BOX IS NOW FULLY ASSEMBLED AND READY TO ENJOY!**

PICTURE 6



!! WARNING: Safety Hinge Lid Support must be installed properly !!

If not installed or if installed improperly, the Barrel Top Lid (I) could free fall and slam shut unexpectedly causing serious injury. The Safety Hinge Lid Support (L) has been installed properly if, after Step 6, the lid remains open when unattended.

No maintenance or lubrication of the Lid Support (L) is required. The lid will open to a full 90°, or can be opened to any position in between the fully closed and fully open positions.

CARE INSTRUCTIONS:

To clean, wipe with a damp cloth and mild detergent as needed. Periodically check all of the hardware to make sure it remains tight.

