

CATALOG NUMBER	TYPE
PROJECT	

LOW VOLTAGE TRACK HEAD

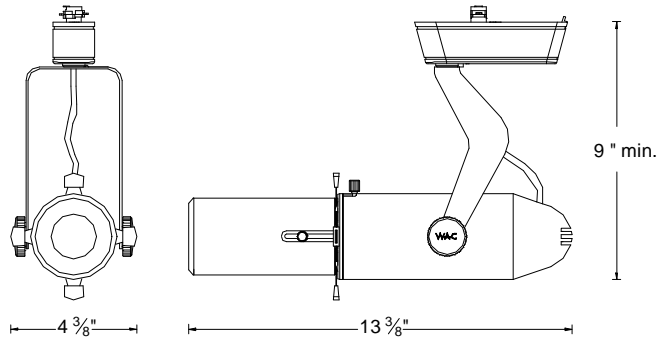



Ordering Matrix			
Model		Series	Finish
<input type="text"/>		<input type="text"/>	<input type="text"/>
HHT	JHT	LHT	009L
		BK	WT

Ordering Example (model – series – finish): HHT-009L-BK

Product Details	
Description:	Premier series low voltage track mounted framing projector for use with WAC brand H, L, J & J2 series track systems. In addition it may fit other manufacturer's original track (consult factory for specific brands).
Materials:	Die-cast aluminum track head with polycarbonate transformer case and track adapter. Two focusing lenses and metal shims contained in framing snoot. Bi-pin ceramic socket for MR16 lamp.
Aiming:	350° horizontal rotation and 90° vertical aiming. The screw and swivel yoke aiming allows precise adjustment to the desired angle.
Lamp & Transformer:	MR16 lamp, 75w max. FPA or EYF lamp type recommended. Lamp sold separately. Integral electronic transformer for 12 volt MR16 lamps. 120V input. Dimmable with electronic low voltage dimmers.
Systems:	HHT is used with the WAC H system track (HT). JHT is used with the WAC J system and J2 system track (JT & J2-T). LHT is used with the WAC L system track (LT).
Finish:	Abrasion resistant black (BK) or white (WT) paint finish.
Listing:	U.L. & C.U.L. listed. 5 year WAC Lighting product warranty.

Specification Features
<ul style="list-style-type: none"> Track mounted framing projector for illuminating artwork and displays. Accepts "D" sized metal or glass gobos for projecting images. Glass photo gobo's should have 50mm retaining ring. Can use one lens accessory such as a colored dichroic lens, UV filter lens, frosted lens, etc. See catalog or website for full lens accessory selection. "Quick-Ship" item, always in stock and available for immediate shipment.

Compatible Accessories	
<p>JCLIP Ordered when using track heads on 2nd circuit of J2 style track.</p>  <p>Order as JCLIP</p>	<p>Low Voltage Extensions Factory installed. Available in 6", 12", 18", 24", 36", 48", 72", 96" lengths.</p>  <p>Order as X(<i>length</i>)</p>

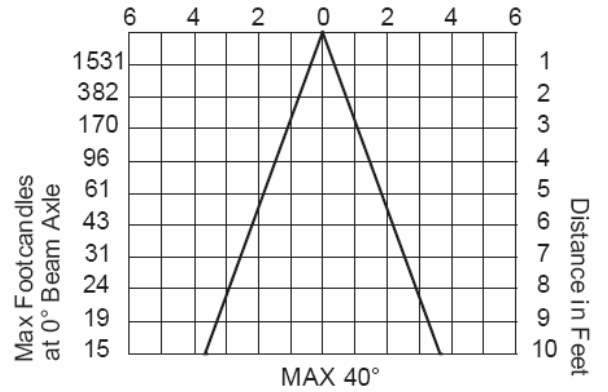
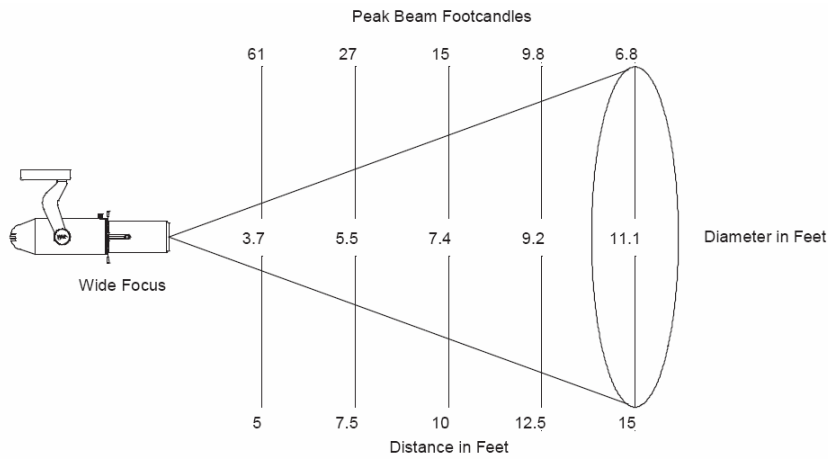
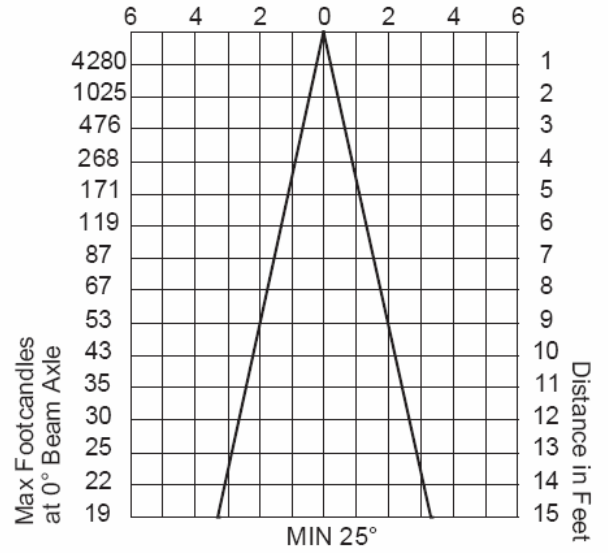
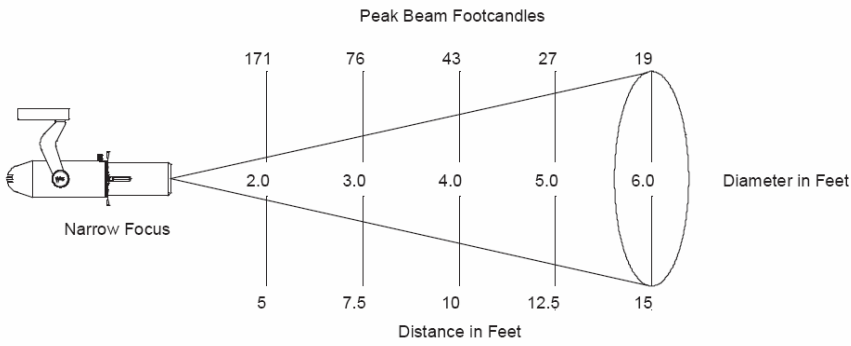

*Data Based on GE MR16-EYF Lamp