

OWNER'S MANUAL



Gourmet Series Marine Gas Grill Model A10-918



For questions regarding performance, assembly, operation, parts, or returns, contact the experts at MAGMA by calling TOLL FREE IN U.S.A. AND CANADA **1-800-86-MAGMA**

7:00 a.m. - 5:00 p.m. Pacific Time Monday thru Friday or e-mail us at mail@MagmaProducts.com



Read all instructions before operating. Save manual for future reference.

IMPORTANT SAFETY WARNINGS

READ ALL INSTRUCTIONS BEFORE OPERATING.

- USE OUTDOORS ONLY.
- DO NOT USE THIS APPLIANCE INSIDE THE BOAT OR ANY ENCLOSED SPACE.
- GRILLS RADIATE HEAT. CLEARANCE FROM COMBUSTIBLES, 24" SIDES AND BACK. NEVER USE UNDER AWNINGS, PATIO COVERS, ETC.
- USE PROPANE GAS ONLY. FUEL STORAGE SHOULD BE IN COMPLIANCE WITH THE AMERICAN BOAT AND YACHT COUNCIL (ABYC) STANDARDS A-1 (9), MARINE LIQUIFIED PETROLEUM GAS (LPG) SYSTEMS.
- FOR NATURAL GAS APPLICATION CONTACT MAGMA.
- ALWAYS LIGHT GRILL WITH LID OPEN.
- NEVER LEAVE HOT GRILL UNATTENDED.
- USE HOT PAD WHEN HANDLING.
- ALWAYS TURN GRILL OFF AFTER USE.

Each Magma® Gas Grill is individually fire tested before it leaves the factory. For this reason, the burner on your grill may be slightly discolored.

INSTALLATION INSTRUCTIONS

CONTROL VALVE REGULATOR

- Uses standard 1-lb. disposable propane canisters (DOT-39 NRC 228/286).
- Prior to installing valve, become familiar with the valve function and graphics on valve knob. Never force the knob. Always turn or push gently.
- Turn control valve to "lock"  and install gas canister being careful not to cross the threads. Check for leaks prior to use.
- Position valve with gas bottle as shown **(A)**. Gently insert valve stem into valve chamber while rotating until valve stem key aligns with valve chamber lock detent allowing valve to fully insert. Rotate gas canister down and away so knob faces you **(B)** or straight up **(C)** depending on application.

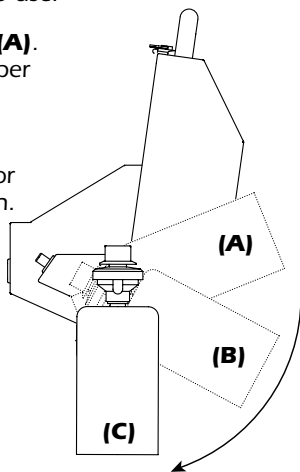

MOUNT HARDWARE

Fasteners are supplied for both Single Mount and Dual Mount grill mounting options. See Magma Catalog or Website for best mount selection.

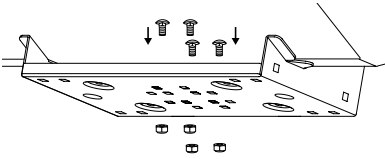

Single mount through-bolt applications

4 Carriage bolts & lock nuts.

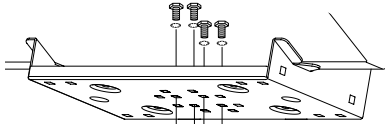

Single mount non-through-bolt applications, including Style 1 "Levelock"

4 Hex head bolts & lock washers.

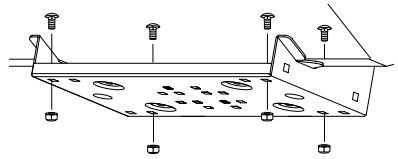

Dual mount applications

4 Carriage bolts & lock nuts. Only 4 bolts required for grill mounting. Place bolts (2 per side) diagonally from each other as shown.



Carriage bolt & lock nut

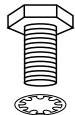

Hex head bolt & lock washer

ON-BOARD FUEL SYSTEMS APPLICATION

- For on-board LPG (Propane) Systems, use Magma Type 3-Low Output-Low Pressure LPG Control Valve and Magma Low Pressure LPG Hose Kit.
- For on-board CNG (Natural Gas) Systems, use Magma Type 4-Low Output-Low Pressure Natural Gas Control Valve.

See Magma website for replacement part numbers and valve applications.
www.MagmaProducts.com

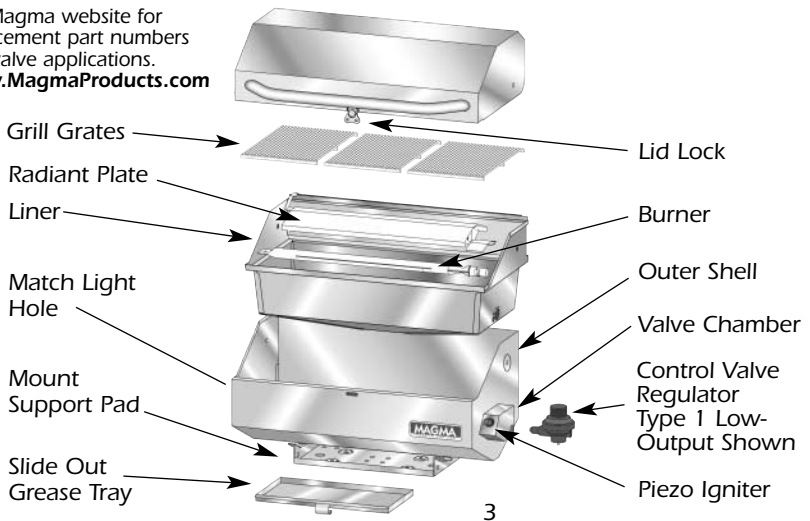

OPERATING PROCEDURES

**OPERATE ONLY ON "LOW" WHEN LID IS CLOSED.
ALWAYS OPERATE WITH GREASE TRAY IN PLACE.**

WARNING: Do not overheat grill. Magma Grills do not require pre-heating. Stainless Steel loses anti-corrosive characteristics when subjected to extreme heat. Most grilling is done on low temperature with the lid closed. If medium or high heat is required, grill with lid open.

LIGHTING INSTRUCTIONS

- Open lid during lighting.
- Depress knob and rotate counter-clockwise to the "HIGH" flame  position.
- Push Piezo Igniter.
- Visually confirm ignition through match light hole.
- Turn knob to adjust flame.
- If grill does not light, repeat process.

MATCH LIGHTING INSTRUCTIONS

- Open lid during lighting.
- Depress knob and rotate counter-clockwise to the "HIGH" flame  position.
- Hold match or gas flame long lighter up to the match light hole.
- Visually confirm ignition through match light hole.

TO REDUCE FLARE-UP

- Empty and clean grease tray prior to each use.
- Trim excess fats from meat.
- Use non-oil based marinades.
- Reduce heat.
- Use water spray directly on flare-ups.

NOTE: Before lighting, lid lock must be positioned not to engage. Open lid and turn lock to locked position, or bring lock latch up to handle in open position and flip lock actuator back onto handle.

PRACTICAL HINTS:

Before lighting your grill, be sure that ...

- Grill is secure and properly mounted.
- Internal components and grease tray are clean and correctly positioned.
- You have plenty of gas in the canister.
- Gas canister is attached properly and there are no gas leaks.
- Lid lock has been set not to engage.
- You have a water spray bottle handy to cool a hot grill or stop any flare-ups.

STOWING TIPS

- Always disconnect the fuel canister from the valve prior to stowing.
- Stow the valve in a clean, dry area to protect from corrosion to valve.
- Always store propane in a sealed propane storage locker that allows leakage to vent overboard or use **Magma A10-210 Propane Storage Tote**.
Never stow below decks



ELECTRODE SPARK ADJUSTMENT

CAUTION: Spark can cause small shock. Do not leave fingers on or near electrode wire while engaging igniter.

- Electrode wire should be approximately 1/8" from gas exit hole in burner. Carefully adjust wire if required.

DISASSEMBLY & RE-ASSEMBLY

- Lift radiant plate up & out of left slot (see B) and remove by sliding it out of right slot (see C).
- Remove burner screw (see B) and remove burner. Check burner for grease residue or spider webs that may obstruct gas flow. **CAUTION: WHEN REPLACING BURNER, CUT SLOT IN BURNER MUST FACE DOWN.**
- To remove liner from outer shell you must disconnect the electrode wire (see D). First remove the two screws on valve chamber (see D) and remove the cover plate. Gently pull wire off connector (see D). It is not necessary to remove electrode from liner.
- Remove Lid and liner by removing hinge screws and lock nuts with 3/16" hex key wrench (supplied) and 1/2" wrench or pliers. **CAUTION: LOCK NUTS MUST BE INSTALLED WITH LOCKING INDENT MARKS SHOWING (see E). IMPROPER INSTALLATION WILL DAMAGE THE HINGE SCREW AND LOCK NUT.**
- Lift liner out of outer shell by lifting up on liner lip on back side of liner (see F). When replacing liner, be sure top lip of liner installs over top edge of outer shell (start with corners of lip and work in).
- Inspect burner, remove any obstructions.
- Clean as indicated in Maintenance (page 6).
- To re-assemble, reverse the procedure.

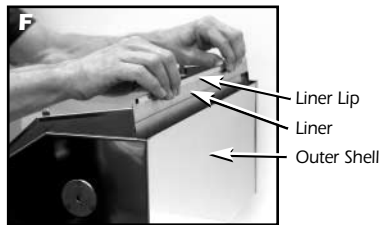
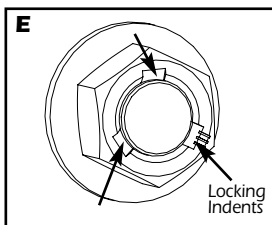
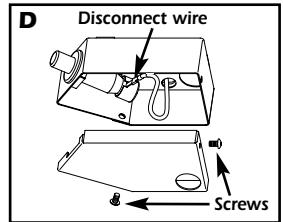
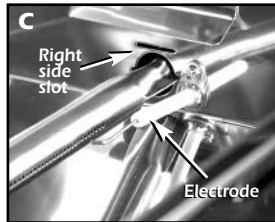
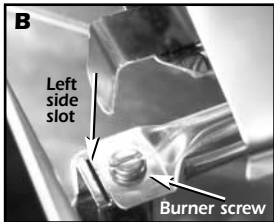

MAINTENANCE

About Stainless Steel - Stainless steel exposed to prolonged periods of high heat will change color and texture. Magma grills require no preheating. Not preheating will keep your grill cooler and greatly extend the life and beauty of your grill. Texture and color change is normal on interior components and will not affect the product's operation or performance.

Exterior Stainless Steel Components - Cleaning the exterior surface after every use will help prevent discoloration. Use soapy water with a soft cloth or sponge. Rinse thoroughly with fresh water and dry. We recommend covering the grill between uses. Optional covers are available from Magma retailers or direct from Magma. **CAUTION: ABRASIVE PADS OR CLEANERS WILL DAMAGE THE FINISH.**

Interior Components - Remove heavy residue from grill and empty grease tray between each use. We recommend complete disassembly and cleaning at least once a year depending on amount of use (see page 5) and always prior to long term storage. For burnt-on residue we recommend Easy-Off brand Oven & Grill Cleaner. If cleaner is used on liner or lid, complete disassembly is recommended to remove any cleaner residue left between components. Wash all components with soapy water after using cleaner. **CAUTION: AVOID CONTACT OF IGNITER AND ELECTRODE WIRE AND WIRE CONNECTORS WITH OVEN CLEANER.**

Grill Grates - Clean with brass wire brush while grill is warm. Use Oven & Grill cleaner for burnt-on residue. Wash with soapy water and dry prior to storage.

Ceramic Electrode - Located just beside the burner, it should be kept clean of grease and debris. Be careful not to damage the ceramic insulation or bend the wire. See page 5 for electrode spark adjustment.

Control Valve - All valves are set and tested at our factory. Do not attempt to adjust or disassemble the valve in any way. Call Magma if you suspect it is not adjusted properly. Clean valve with a cloth and remove any debris obstructing the gas outlet orifice using a pin or needle.

Repair/Replacement Parts - See Magma's Website for a complete list of Repair or Replacement Parts. www.MagmaProducts.com

USING GRILL WITH ON-BOARD LPG (PROPANE) SYSTEMS

- Magma On-Board LPG (Propane) Valves and Hose Kits allow Magma Grills to be installed within a boat's existing on-board, pre-regulated low pressure LPG (Propane) system.

- Use only **Magma Type 3 Low Pressure LPG (Propane) Valves**. See our **Valve Application Guide** at www.MagmaProducts.com for correct valve.

- In North America use **Magma A10-225 LPG 10' Hose Kit** in conjunction with **Type 3 Valve**. Outside North America check your local dealer for proper hose and fittings.

- A primary shutoff valve (**supplied with A10-225 hose kit**) must be used with this control valve at point of connection into your system. This allows shut off of gas supply to hose leading to grill.

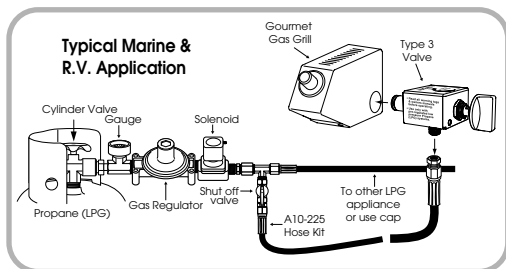
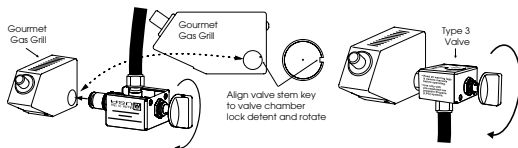

TROUBLE SHOOTING GUIDE

Problem	Possible Cause	Possible Solution
Burner will not light with igniter	Igniter electrode covered with grease or residue	Clean igniter electrode
	Igniter/electrode too far from burner	Adjust electrode until proper spark appears (see page 5)
	Igniter/electrode wire loose or disconnected	Reconnect wire between igniter & electrode (see page 5)
	Wire is shorted causing spark from wire before electrode	Call Magma
	No spark being generated	Call Magma
Burner will not light even with match	No gas flow	Check fuel level, refill cylinder or replace canister
	Obstructed gas flow/debris or spider webs in burner tube	Clean valve orifice and burner, check all lines (see page 6)
Flare-up	Excessive cooking temperature	Operate only on low when lid is closed Reduce flame level Leave lid open Use water spray to cool
	Grease and/or residue build-up	Clean components
	Excessive fat in meats	Trim fat from cuts of meat before grilling
	Excessive oils in marinades	Use non-oil based marinades
Yellow sooty flame	Obstructed gas flow/debris or spider webs in burner tube	Check and clean valve orifice and burner (see page 6)
Blow-out	Flame too low	Increase flame
	Wind directly on burner	Block wind when opening lid
	Obstructed gas flow	Clean burner or valve orifice (see page 6)

Contents

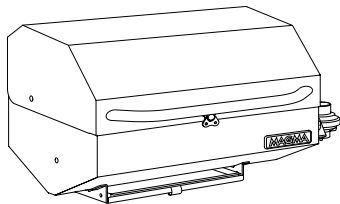
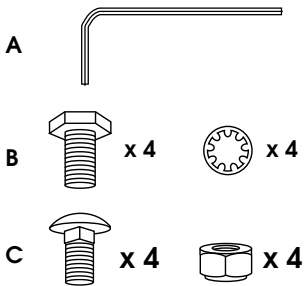

- A)** (1) 3/16" Hex key wrench for lid removal.
B) Pack of (4) 1/4"-20 x 5/8" hex head screws and internal lock washers for "Levelock" single mount application.
C) Pack of (4) 1/4"-20 x 5/8" carriage bolts and lock nuts for dual mount and single mount applications and table legs.

LIMITED WARRANTY

Magma Products, Inc. guarantees this gas grill to be free from defects in materials or workmanship to the original consumer. This guarantee is for the periods herein specified when used under normal and reasonable conditions, one (1) year from the date of original purchase. This warranty does not include the cost of property damage or any inconvenience due to the failure of the product. Nor does it cover damage due to misuse, abuse, accident, or damage resulting from transportation of the product. Nor does it include damage resulting from the commercial use of this product. If the product fails to operate due to a defect in materials or workmanship during the warranty period, the defective part will be repaired or replaced at Magma's option. If you wish to obtain performance under this limited warranty, you should contact Magma's Customer Service Department via telephone at 562-627-0500 or 800-86-MAGMA, or via e-mail at mail@MagmaProducts.com, or via U.S. Postal Service mail at "Magma Products, Inc., attention Customer Service, 3940 Pixie Ave. Lakewood, CA, 90712." The defective part, along with proof of purchase, must be returned postage prepaid to Magma Products, Inc. We suggest that you keep your purchase receipt as we may require reasonable proof of purchase.

In the state of California only, if refinishing or replacement of the product is not commercially practicable, the retailer selling the product, or Magma Products, Inc., will refund the purchase price paid for the product, less the amount directly attributable to use by the original consumer prior to the discovery of the nonconformity. In addition, in the state of California only, you may take the product to the retail establishment from which it was purchased or to any retail establishment selling this product in order to obtain performance under this warranty.

All implied warranties, including the implied warranties of merchantability and fitness for a particular purpose, are limited in duration to the express warranty periods specified herein for the parts described herein.

Some states do not allow limitations on how long an implied warranty lasts, so the above limitation may not apply to you. Neither Magma dealers, nor the retail establishment selling this product has any authority to make any warranties or to promise remedies in addition to or inconsistent with those stated above. Magma's maximum liability shall not exceed the purchase price of the product paid by the original consumer. Some states do not allow the exclusion or limitation of incidental or consequential damages, so the above limitation or exclusions may not apply to you. The warranty gives you specific legal rights and you may also have other rights which vary from state to state.

MAGMA and the Magma logo are registered trademarks of Magma Products, Inc.
Newport is a trademark of Magma Products, Inc.
Patent pending.

CALIFORNIA PROPOSITION 65 – WARNING – The burning of gas cooking fuel generates some by-products, which are on the list of substances, which are known by the State of California to cause cancer or reproductive harm. California law requires businesses to warn customers of potential exposure to such substances. To minimize exposure to these substances, always operate this unit according to the use and care manual, ensuring you provide good ventilation when cooking with gas.



Magma Products, Inc.

3940 Pixie Avenue, Lakewood, CA 90712 ■ USA

Phone (562) 627-0500 ■ e-mail: mail@MagmaProducts.com

www.MagmaProducts.com